

Subject	Page
Lamp Module and Xenon Lights	72
Lamp Module (LM).	73
LM I.P.O..	75
Input Signals.	76
Emergency Operation.	77
Light Check Module (LCM).	78
Light Check Module III (LCM III).	79
Xenon Headlights.	80
Xenon Bulb Monitoring.	83
Xenon Headlight Testing.	84
LWR- Headlight Beam Throw Control.	85
LWR Components.	86
Functional Description.	87
LWR I.P.O..	88
Multi Information Displays	89
E38 Multi Information Display.	90
MID Self Tests.	92
On-Board Computer (BC).	93
E39/E53 Multi-Information Display (MID).	96
MID Self Test.	98
MID Removal.	99
On-Board Computer.	100
Multi Function Steering Wheel (MFL) and Cruise Control II (GRII)	101
Multi Function Steering Wheel (MFL).	102
Heated Steering Wheel.	103
GR II	104
Components of the system.	105
GR II I.P.O..	109
Plausibility/Safety Features.	110
Diagnosis/Encoding.	111
Audio Systems	112
E38 Without Board Monitor.	113
Radio Test Functions.	114
E39/E53 Without Board Monitor.	115
Radio Test Functions.	115
New Generaton Radios.	116
Park Distance Control (PDC)	124
PDC Components.	125
System Operation.	127
Diagnosis.	128
Review Questions	129

LAMP MODULE (LM, LCM, LCM III) AND XENON LIGHTS

Model: E38, E39, E53

Production Date: From start of production

Objectives

After completing this module you should be able to:

- Recognize the various changes made to the LM/LCM over the years.
- List the functions performed by the LM/LCM.
- Describe how the LCM monitors the external lights.
- Explain how the LCM stores redundant data.
- Describe the operation of Xenon lights.
- Know how to troubleshoot a Xenon light circuit.
- List the components used in the LWR system.

Lamp Module (LM) (E38 start of production up to 9/95)

The Lamp Module (LM) is designed to control and monitor all the outside lights on the vehicle. Various displays and switches are also illuminated by an LM function.

The LM incorporates power transistor output stages with internal protection circuits. This eliminates the need for fuses and relays that are found on earlier lamp control systems.

The LM is located in the passenger side kick panel behind the footwell speaker. This location provides an airflow across the external heatsink to cool the LM.

The LM reduces a number of components that were used in the past. Eliminated are:

- Numerous relays
 - Flasher unit
 - Crash control unit (relay)
 - Cold check relay
 - Dimmer
- The LM transmits and receives status information concerning light operation. The LM transmits bulb status to the check control module.
 - It also communicates to the IKE when turn signal, highbeam, and fog light indicators need to be activated.
 - The LM is informed by ZKE when a crash has occurred or the alarm was tripped for headlight / flasher activation.
 - When reverse is selected, the LM is signaled to turn on the back-up lights.

All of this communication takes place over the Bus system.

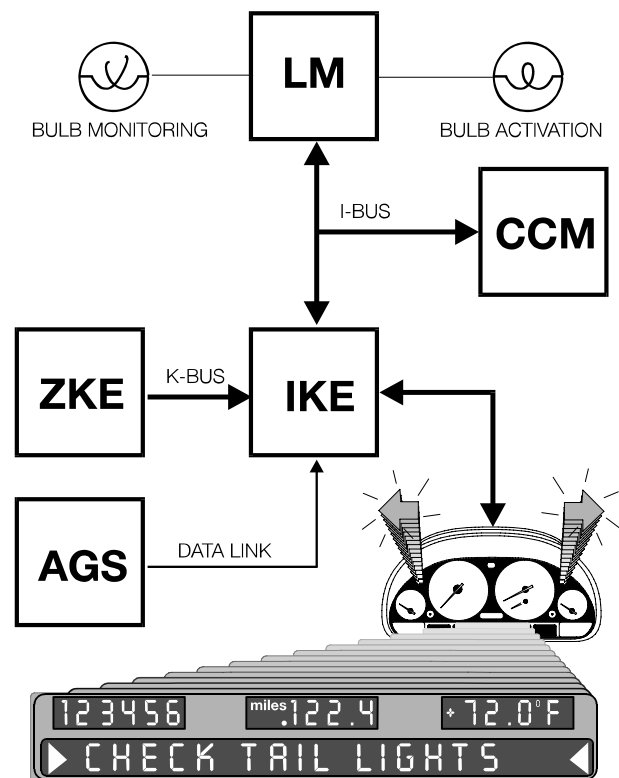
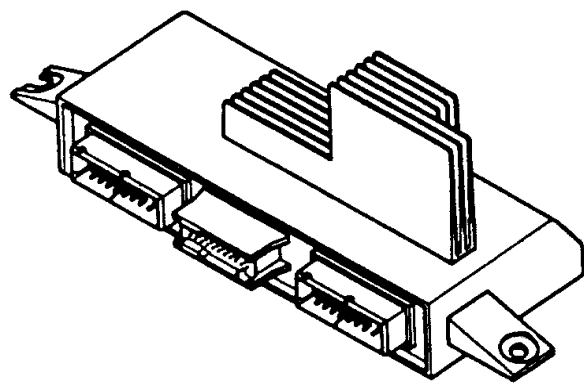

The LM monitors most of the vehicle's lighting circuits with warm and cold check functions.

- The warm check is performed by electronic diagnosis at the output stages.
- Cold checking is done by switching on the light circuits briefly. In other words, it is a very rapid warm check. This is repeated in timed cycles.

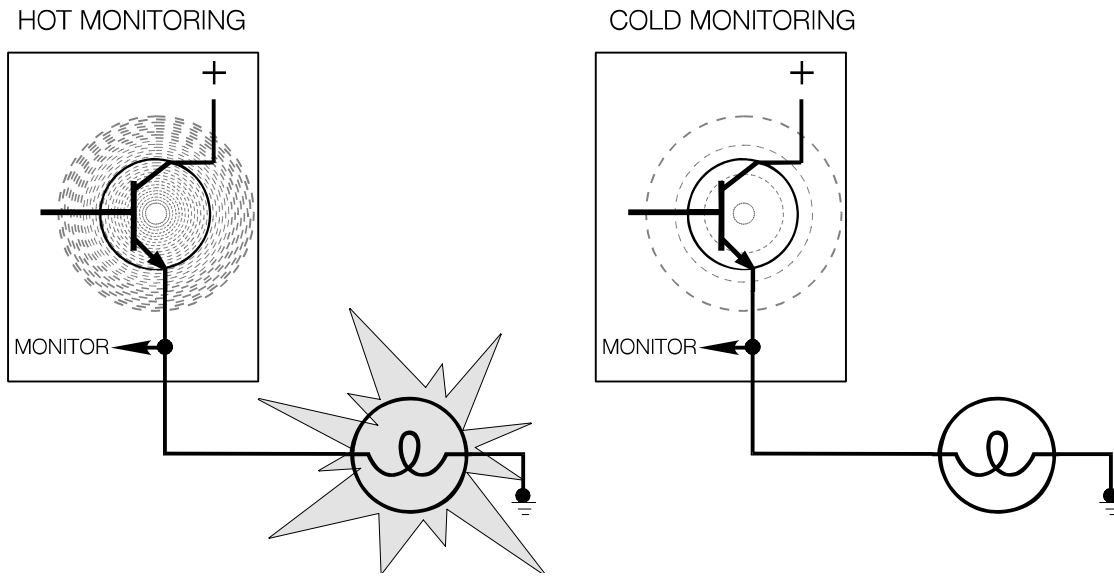

In order to simplify wiring in the E38, the LM operates the brake lights with inputs received from an electronic brake light switch.

For safety purposes, the LM is designed with emergency functions in case of failure. The failure of any one component doesn't disable the entire system.

Important vehicle-specific data is stored in the LM. Replacement of this module is covered in the IKE module of this training handout.

BULB MONITORING

The extent of bulb checking is governed by LM coding. Certain monitoring functions can be shut down. For instance, if Xenon low beam lights are installed, low beam cold check is turned off.

Faulty turn signal bulbs and circuits are indicted by rapid flashing of the cluster indicator.

Bulb	Watt Rating	Monitoring	
		Hot	Cold
Low Beam Headlight	65	X	X
High Beam Headlight	55	X	X
Foglight	55	X	X
Front Side Light	5	X	X
Blinkers	21	X	
Blinker Indicators	5		
Tail Lights	5	X	X
License Plate Lights	10	X	X
Brake Lights	21	X	X
Back up Lights	21	X	X

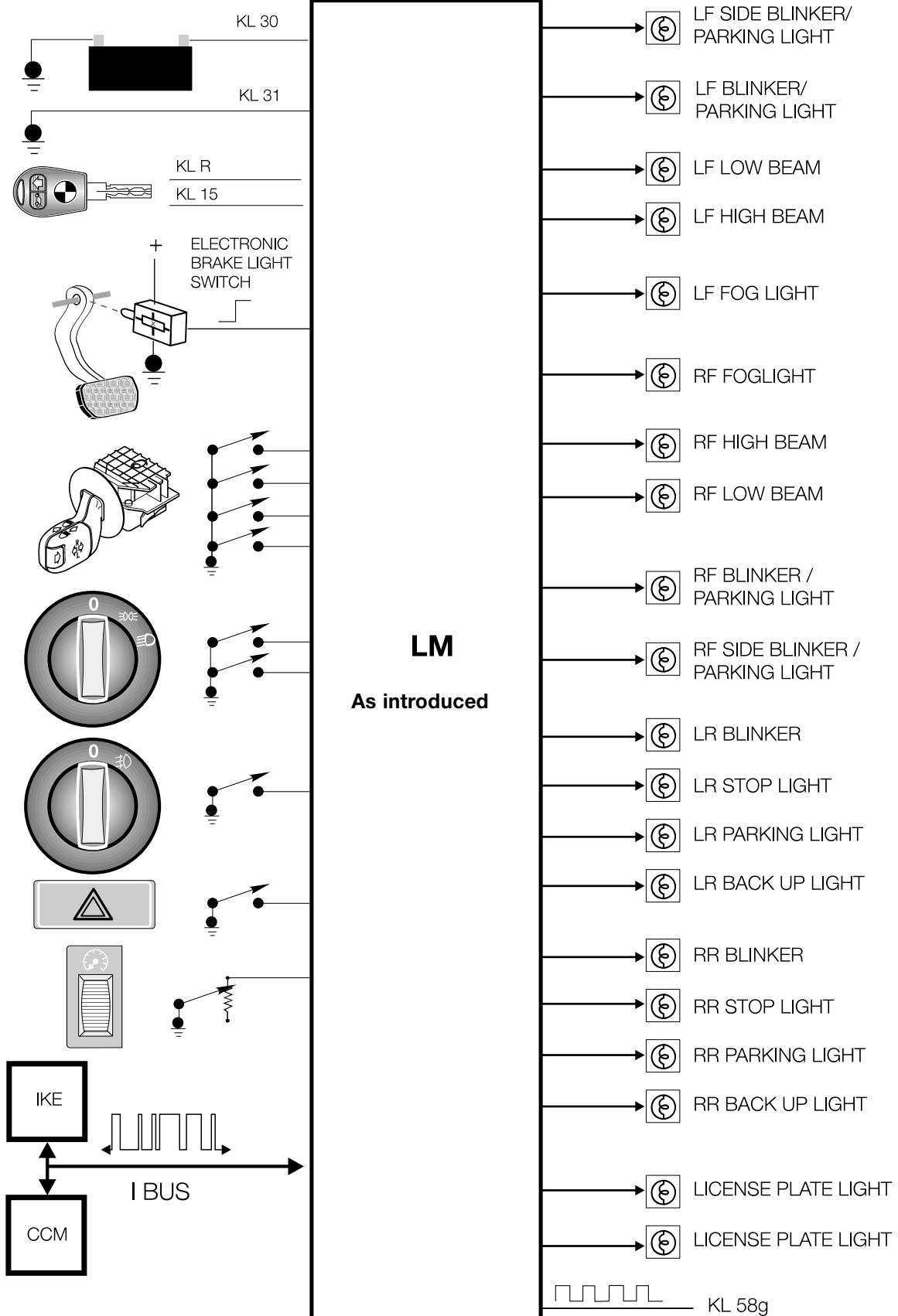

Input Signals

Input signals to the lighting module are from the following switches:

- Park / low-beam light switch
- High-beam/headlight flash switch
- Turn signal switch
- Fog light switch
- Hazard switch
- Brake light switch
- Dimmer control

These inputs are ground switched except for the brake light switch.

Brake Light Switch - Brake light switch is a hall-effect transmitter with three connections. The first connection is power, supplied from KL R, with the second being ground. The third connection is the signal wire to the LM.

If the brake switch or it's circuits fail, the brake lights will be permanently on from KL R.

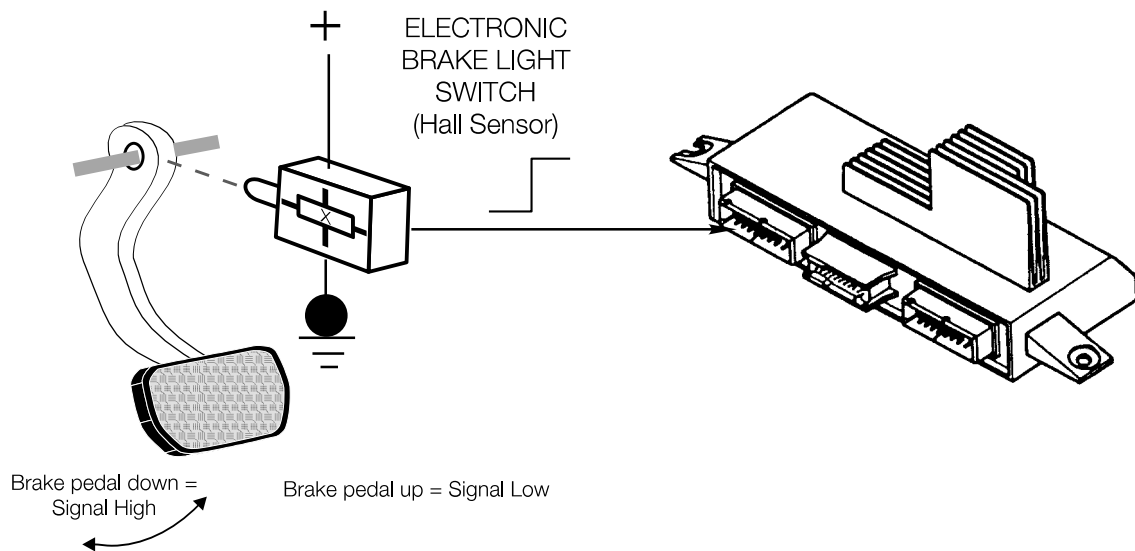

Dimmer - The LM control KL 58g (instrument cluster, LCD, and switch back lighting). By using a pulse-width modulated power supply, dimming commands are input to the LM by way of a potentiometer wired to ground.

Light switch illumination - A separate circuit is used to back light the symbol of the light switch. The symbols are fully illuminated when KL R is switched on and the lights are off. After the lights have been turned on, the switch back lighting is reduced to the same intensity as KL 58g.

EMERGENCY OPERATION

If there is a failure of the LM processor, an emergency circuit is activated within the LM. This will allow the following lights to function for driving safety.

- Side marker/tail lights
- Low-beam lights
- Brake lights
- Turn signals

In emergency operation the following lights **will not** operate

- Dimming control (full bright)
- Hazard lights
- High-beam lights
- Headlight flash
- Fog lights
- Back-up lights

The I-BUS communication to the LM will also be interrupted.

Light Check Module (LCM) (E38 and E39 from 9/95 to 9/98)

The Light Check Module (LCM) combines the functions of the Check Control and Light Modules previously installed in the 1995 E38. The LCM provides a cost savings by combining the two functions into one processor.

It is installed in the right kick panel where the LM of the 95 E38 was installed. Both versions of instrument clusters use the LCM for processing Check Control data and controlling the exterior lighting functions of the vehicle. The LCM communicates with other modules over the "I" and "K" busses. Functions of the LCM include:

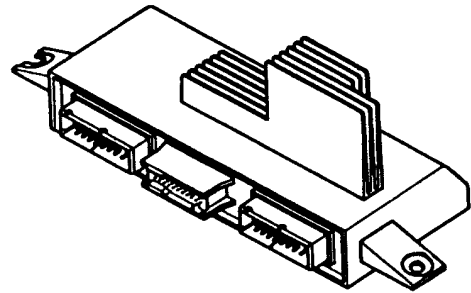

- Monitoring of all check control inputs
- Formation and output of check control messages or signals
- Control of all vehicle external lighting
- Monitoring of all external lighting for operation
- Instrument panel illumination dimming (KL 58g) signal
- Control of instrument cluster indicator lights - for high beam, turn signal and fog light indicators.

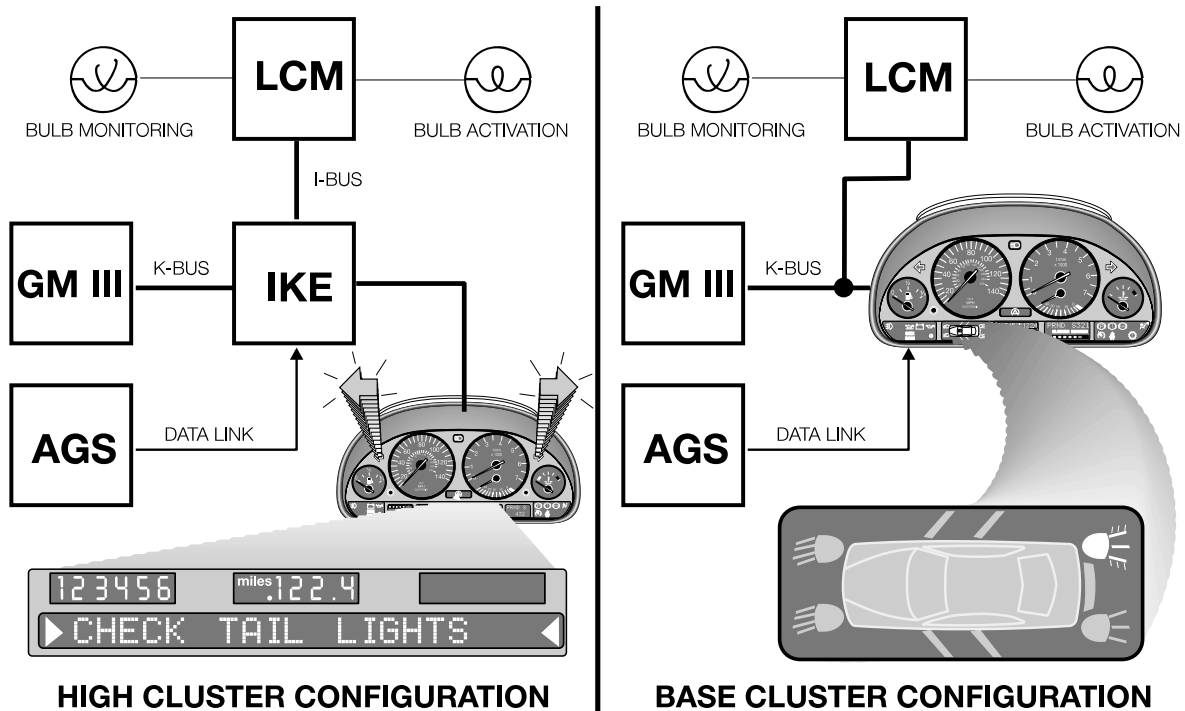

For proper operation of the Check Control and lamp control functions, the LCM must be coded with the Central Coding Key (ZCS) if replacement is required.

Light Check Module III (LCM III) (E38, E39, E53 from 9/98)

The light check module LCM was redesigned as of 9/98 production. It is identified as the LCM III.

The module itself has been redesigned with new semi-conductor final stages that produce less heat in operation. This has allowed for the elimination of the protruding heat sink found on the previous LCM.

The total scope of function and features has been expanded to improve the comfort and safety for the driver and passengers of the vehicle. Feature and functional changes to the LCM III include:

- Replacement lighting for the parking lights
- Limiting of output voltage to the lamps
- Follow Me Home (delayed exit) lighting

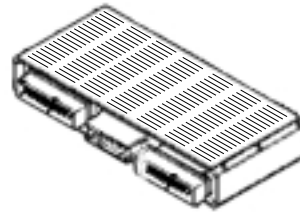

Replacement Lighting

The LCM can use substitute bulbs for various lights if a failure should occur, for example:

- **Front Parking Lights:** If one of the parking lamps should fail, the LCM will illuminate the turn signal bulb on the affected side. The lamp will be dimmed by the LCM so that the intensity is the same as the parking lamp.
- **Rear Taillights:** If one of the rear taillights should fail, the LCM will switch on the brake lamp on the affected side. The lamp will be dimmed to the intensity of the tail lamp.

Output Voltage Limiting Function

The output voltage applied to the parking and tail lamps is regulated to increase the life of the lamps. If the voltage at the LCM increases over 12.5 volts, the LCM will reduce the voltage to 12 volts.

Follow Me Home Lighting

This convenience feature provides lighting for the driver and passengers to leave the vehicle and enter their homes.

The feature is switched "ON" by pulling the headlight flasher switch after the headlights and ignition have been switched OFF. The feature is switched OFF after a coded time delay or by switching the ignition ON.

Xenon Headlights

Overview

The automotive industry/press often identify xenon lighting systems as HID (high intensity discharge) systems. Xenon headlight technology was first introduced to the US market exclusively on the E32 750iL in 1993. BMW xenon headlight systems have evolved and their availability as optional equipment has spread throughout the model lineup.

Blue/White in color and using ellipsoidal technology Xenon headlights provide improved night time visibility in all driving conditions compared with traditional Halogen bulb headlights.

Benefits:

Xenon headlights provide the following benefits:

- **Longer bulb life.** Typically, xenon bulbs will last from 3 to 5 times longer than halogen.
- **More light output.** Xenon headlights produce from 2.5 to 3 times more lumens than halogen.
- **Blue/White light** (*simulates natural daylight*). Xenon bulbs produce a blue/white light while halogen bulbs produce a yellow light. The light color of a light source is measured in color temperature (not to be confused with thermal temperature). Color temperature is measured in Kelvins (K). The higher the color temperature the whiter the light.

Natural daylight = 4,500 to 5,000 K

Xenon headlights = 4,000 to 4,500 K

Halogen headlights = 3,200 K (yellow in color)

- **Better driving visibility.** The combination of higher lumens and higher color temperature provide a superior lighting source.

The beam is wider and brighter in front of the vehicle than conventional halogen bulbs improving safety and driver comfort.

- **Lower operating temperature.**
- **Lower power consumption.**

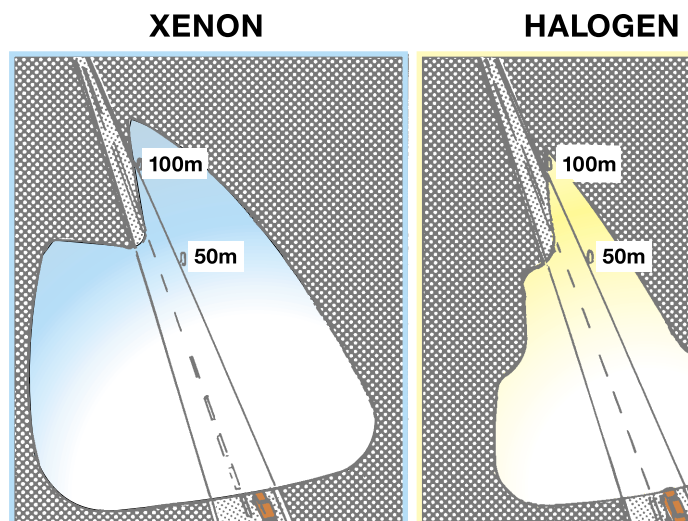

Version Identification & System Summaries

Version identification is specific to vehicle model with the exception of the E38.

There are two E38 Xenon systems. The early system identified as **Generation 2.1** and equipped on 95-98 model year 750iL vehicles. The headlight design of this version has a flat bottom edge.

The **Generation 3** system was introduced on 1999 model year E38 vehicles. This system can be visually identified by the rounded bottom edge.

LWR: All Xenon systems from M.Y. 99 are also equipped with LWR (Headlight Beam Throw Control). This system automatically adjusts the vertical position of the headlight beams to compensate for vehicle loads ensuring optimum beam throw. LWR components and function is described further on in this section.

Headlight Replacement Parts: In previous model years, individual replacement parts were not available for headlight assemblies. This was due to the Federal Motor Vehicle Safety Standards (FMVSS) relating to pitting or corrosion of the reflector components in non-sealed beam light assemblies.

BMW has recently submitted corrosion test data for headlight replacement components which have passed the FMVSS providing availability of headlight assembly spare parts. The approval has been given for **all Bosch** headlight assemblies (including halogen systems).

Vehicle/ Model	Model Year	Manufacturer(s)/ Version ID	LWR- Head Light Beam Throw Cont.	Individual Replacement Parts Available
E32/ 750iL	93-94	Hella (Light & CM "control module") Generation 1	No	No
E38/ 750iL	95-98	Bosch (Light & CM) Generation 2.1	No	Yes
E38/ All	99-01	Bosch (light) Hella (CM) Generation 3	Yes	Yes
E39 All	99-	Hella Generation 3	Yes	No
E46	99-	Bosch (Light & CM)	Yes	Yes

Xenon High Intensity Discharge Bulbs

Xenon bulbs are identified as D-2S (D=Discharge). Xenon bulbs illuminate when an arc of electrical current is established between two electrodes in the bulb.

The xenon gas sealed in the bulb reacts to the electrical excitation and heat generated by the current flow. The distinct bluish/white brilliant light is the result of the xenon gas reacting to the controlled current flow.

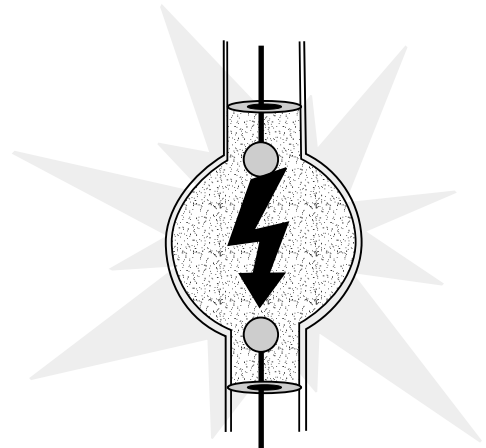

Phases of Bulb Operation:

Starting Phase: The bulb requires an initial high voltage starting pulse of 18-25kV to establish the arc.

Warm Up Phase: Once the arc is established the power supply to the bulb is regulated to 2.6A generating a lamp output of 75 watts. This is the period of operation where the xenon gas begins to brightly illuminate. The warm up phase stabilizes the environment in the bulb ensuring continual current flow across the electrodes.

Continuous Phase: Once the warm up phase is completed, the system switches to a continuous mode of operation. The supply voltage for the bulb is reduced and the operating power required for continual bulb illumination is reduced to 35 watts which is less than a conventional halogen bulb.

Functional Description

To regulate the power supply to the bulbs, additional components are required. The xenon control modules (1 per light) receive operating power from the lighting control module (LCM E38/E39/E53) when the headlights are switched on. The xenon control modules provide the regulated power supply to illuminate the bulbs through their phases of operation.

The igniters establish the electric arcs. Integral coils generate the initial high voltage starting pulses from the control module provided starting voltage. Thereafter they provide a closed circuit for the regulated power output from the control modules.

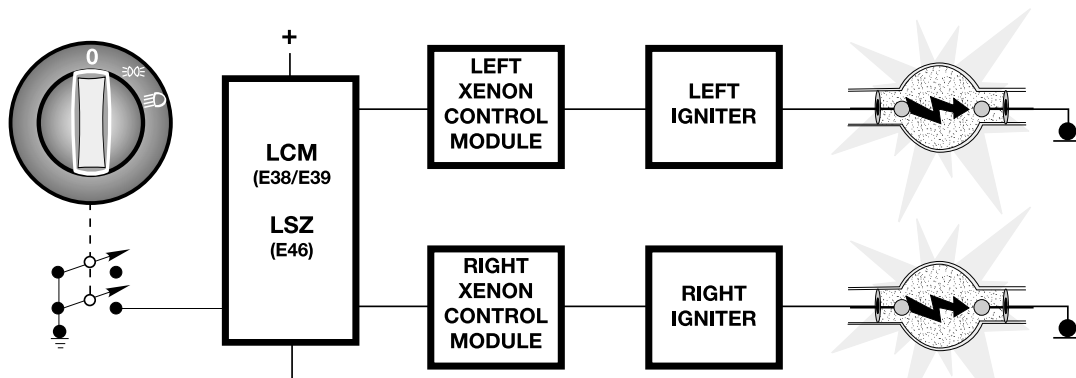

Xenon Bulb Monitoring

Xenon bulb function is monitored by the Lighting Control Module (LCM E38/E39/E53). The bulbs are only “hot” monitored. Cold monitoring is not possible since the lighting control module is not in direct control of the xenon bulb. For this reason cold monitoring for low beam headlights is encoded off in the lighting control module for Xenon headlight equipped vehicle.

The lighting control module detects xenon bulb failure via a reduction in current flow to the xenon control module. When a bulb fails, the xenon control module’s current consumption drops to 60mA indicating unsuccessful xenon bulb illumination. The lighting control module then posts the appropriate matrix display message or LED illumination in the Check Control Pictogram display of the E53 and E39 Low Instrument Clusters.

Xenon Headlight Assembly Components (Example - E53)

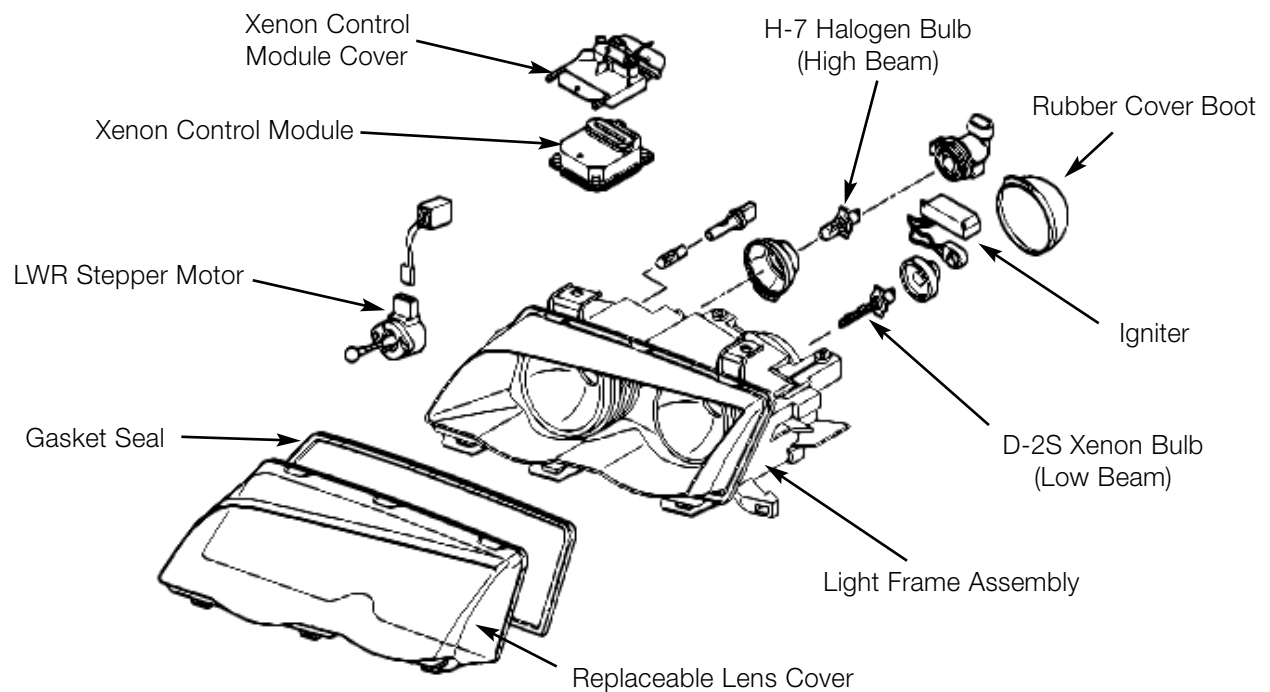

Xenon Headlight Testing

Warning: Xenon headlight control systems generate high output voltage. Prior to headlight removal or testing observe the vehicle warning labels and be cautious by following safeguards to prevent accidental injury.

Xenon headlight systems (control module, igniter and bulb) produced prior to 9/98 can be tested with Special Test Adapter (P/N 90 88 6 631 000) in conjunction with the **DIS** Pre-set Measurements System.

The DIS Measuring System includes all of the cable connection information and procedures for the test.

Generation III Xenon lights on vehicles produced after 9/98 are tested with a different tool. Xenon test adaptor P/N 90 88 6 631 010 is used along with DIS/MoDiC pre-set measurements "Xenon lights after 9/1998".

The Generation III test adaptor uses the 50 amp test cable with both the MoDiC or DISplus.

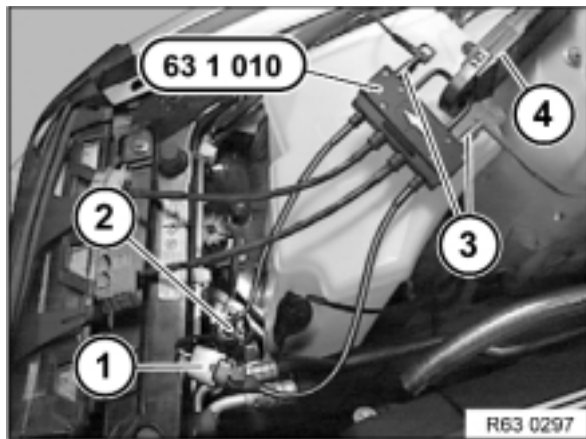

- 1&2** Adaptor connected in series with headlight harness.
- 3** MFK 1 Pos. and Neg. input leads.
- 4** 50 Amp clip on probe.

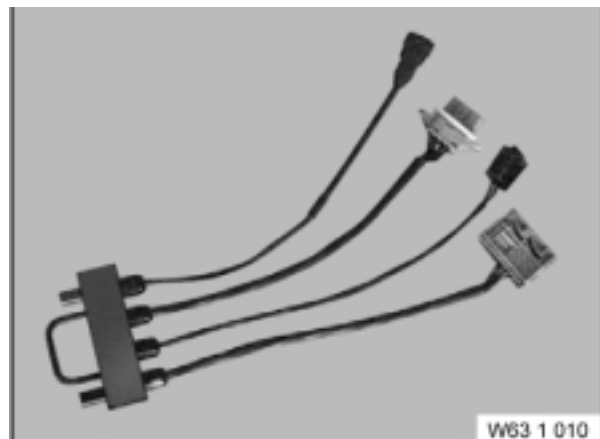

Xenon Generation III Test Light Cable (90 88 6 631 010)

In addition to the Measurement System tests there are also Test Modules available in the Diagnosis Program to diagnose vehicles with Generation 3 Xenon lights.

LWR - Headlight Beam Throw Control

Overview

LWR automatically adjusts the vertical positioning of the headlights to maintain optimum headlight beam positioning for maximum driving visibility and to prevent undue glare for oncoming motorists. The system compensates for vehicle load angle changes (ie: diminishing reserve of gasoline in fuel tank during a long journey, overloaded cargo weight, etc.)

LWR has been available on BMW vehicles in other markets for quite some time. Starting with the 1999 model year all US market vehicles with Xenon Lights incorporated LWR as standard equipment. LWR is not available with standard halogen headlights.

LWR monitors the vehicle's loaded angle via two hall effect sensors mounted to the front and rear suspension members. When an adjustment is necessary, LWR simultaneously activates two stepper motors (one in each headlight assembly).

The stepper motors drive a threaded rod that moves the lower edge of the headlight carrier plate forward and backward (depending on driven direction). The upper edge of the headlight carrier plate is fixed on a pivot. The pivoting movement adjusts the vertical position of the headlight beam.

NORMALLY LOADED VEHICLE

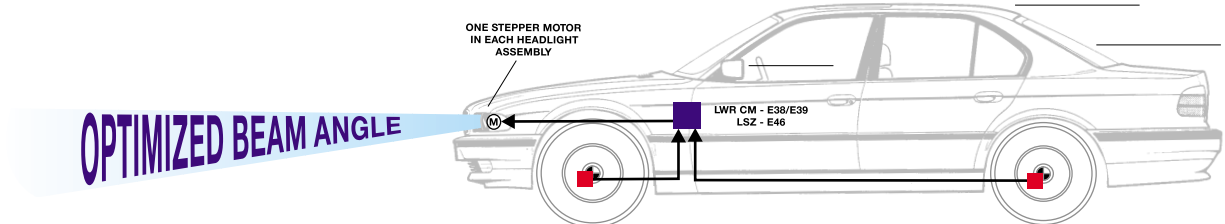

OVERLOADED VEHICLE (EXAGGERATED)

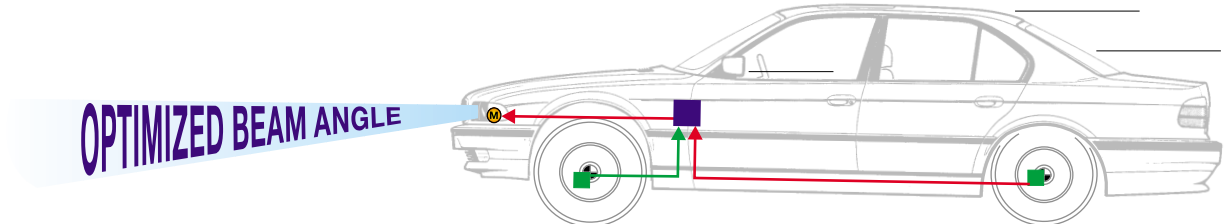

LWR Components

Control Electronics

LWR Control Module - E38 & E39 Vehicles:

The LWR control module is located in the electronics carrier forward of the glovebox. The control module connects to a single, 26 pin, yellow harness connector. The control module has diagnostic capabilities and communicates with the DIS/MoDiC via the K bus - IKE gateway to the D bus.

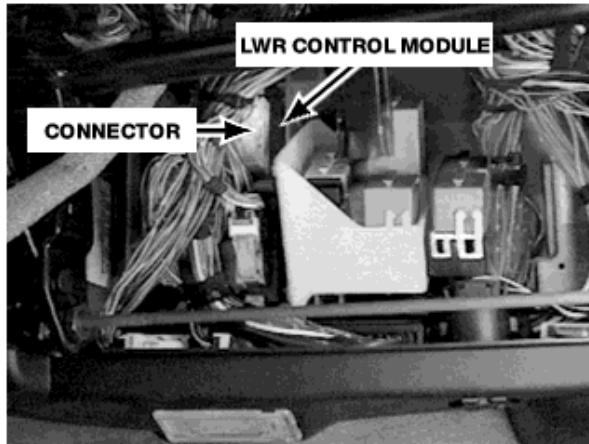

E38 LWR Control Module Location

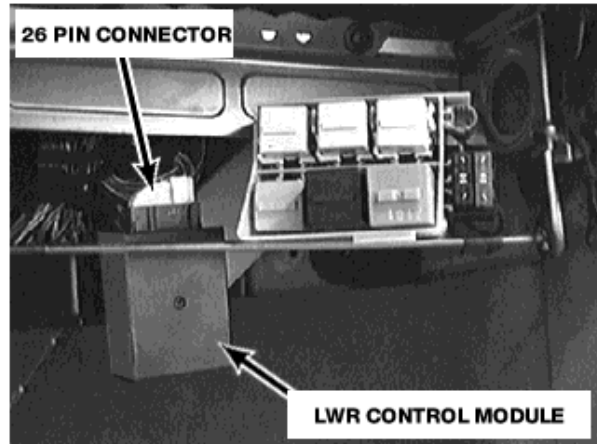

E39/E53 LWR Control Module

Level Sensors

LWR monitors two hall effect level sensors to determine vehicle load angle. The sensors are mounted to a fixed point on the suspension carriers of the front and rear axles.

A lever is connected to the moving suspension member which changes the sensors output linear voltage signal as the suspension moves up and down.

Note: E39 sport wagon vehicles with EHC have a dual output sensor at the right rear location. This sensor shares the same housing as the EHC systems right rear level sensor.

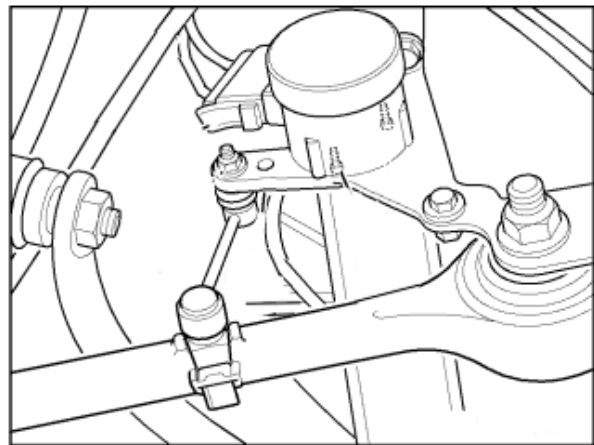

Headlight Adjustment Stepper Motors

One stepper motor is located inside each headlight assembly.

The 4 wire stepper motors are controlled by the LWR control electronics to change the vertical headlight position.

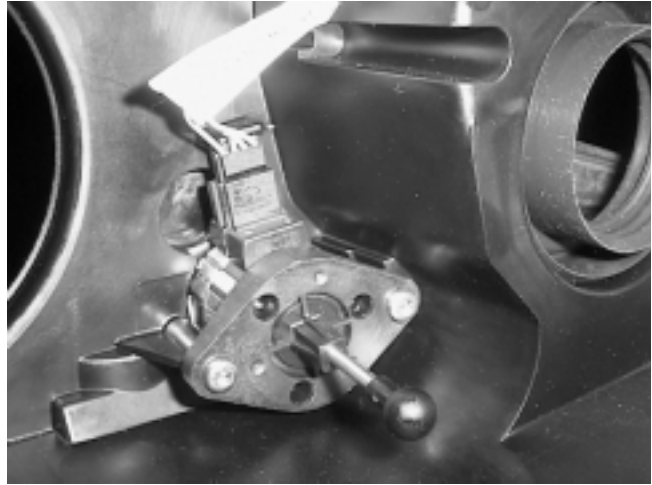

Functional Description

The E38/E39 system comes on-line when the lights are switched on.

The LWR control electronics then cycles the stepper motors through their full range of motion and stops at a default position.

The control electronics monitors the level sensor input signals to determine the vehicles load angle and adjusts the beam position accordingly. As the vehicle is driven it continually monitors the level sensor signals and if necessary updates the headlight beam positions every 25 seconds on the E46 or momentarily on the E38/E39 system.

Abrupt fluctuations of the sensor signals are filtered to prevent unnecessary adjustment as well as monitoring road speed and brake pedal application as correction factors.

HEADLIGHT ALIGNMENT

The procedure for aligning Xenon Headlights with LWR is the same as conventional halogen bulb systems with one additional step. Wait at least 30 seconds for the LWR to cycle and adjust to it's calculated position.

LWR DIAGNOSIS

The LWR control module of the E38/E39 is diagnosable using the DIS/MoDiC. The headlights must be switched on in order to start diagnosis.

The E46 LSZ incorporates LWR diagnosis program.

LWR SYSTEM IPO SCHEMATICS

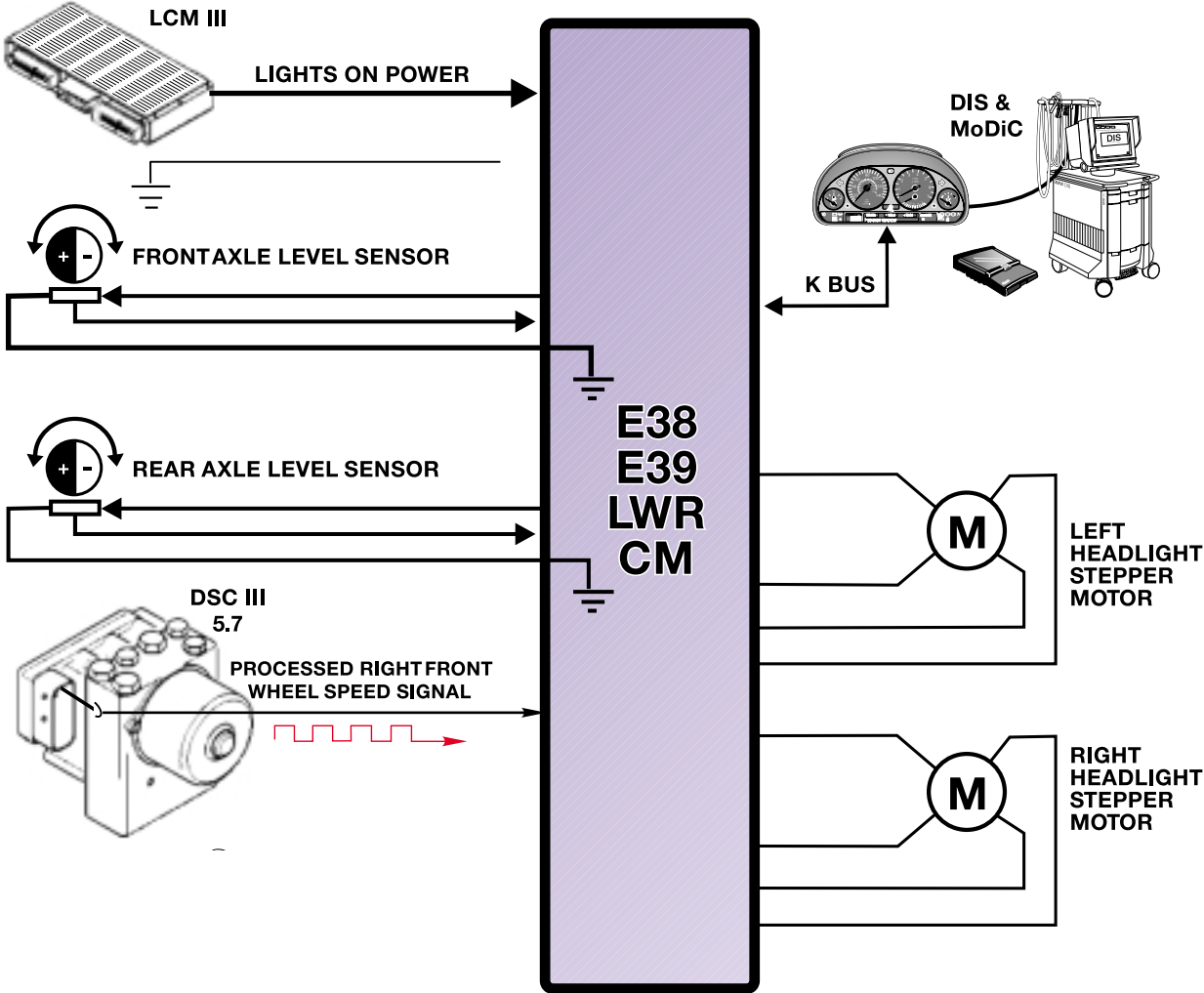

MULTI INFORMATION DISPLAYS

Model: E38, E39, E53

**Production Date: E38: from start of production to 3/99
E39/E53 from start of production**

Objectives

After completing this module you should be able to:

- Explain how information is sent to the MID.
- Describe what operations are possible using the MID.
- Know how to perform a self-test on various MID units.

E38 Multi-Information Display

One of the design parameters of the E38 was to create a more tranquil interior.

The objectives were:

- Reduce the number of control buttons
- Easier operation
- Displays that are easier to understand
- More precise information
- Higher visibility of text
- High Quality appearance

These objectives are achieved with the multi-information display (MID).

The MID incorporates the controls for the audio system, telephone and on board computer. Since the same format is being used to control each of these systems, operation is more convenient.

The MID doesn't perform any calculations. It is an input request / display unit using signals to and from the IKE.

The MID is designed with two displays

- **Main display**- A 32 character display for presentation of primary information
- **Menu Display**- 6 small displays for labeling the button functions.

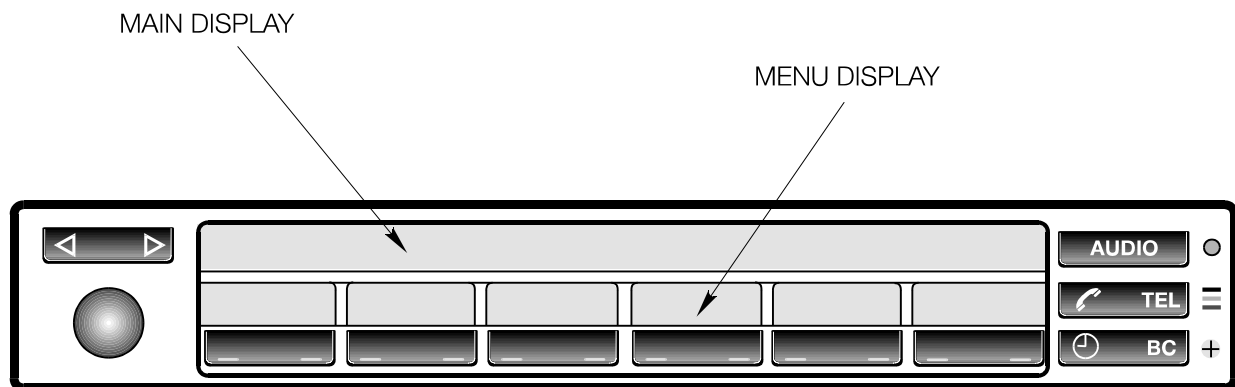

- **Menu buttons** - The buttons are designed as rover switches having a left side and right side contact. The function of each button changes as the different systems are selected.
- **Selector buttons**- These buttons are used to select the desired system to be used:
 - Audio - calls up radio, tape, and CD control for operation and programming functions.
 - Telephone - used to program and call up phone numbers.
 - Time/BC - calls up clock and BC function for programming and display.
- **Search Button** -
 - Radio - Will activate search for radio stations in either up or down scale directions.
 - Tape - activates music search in forward or reverse tape direction.
 - CD - activates title search up or down the title list.

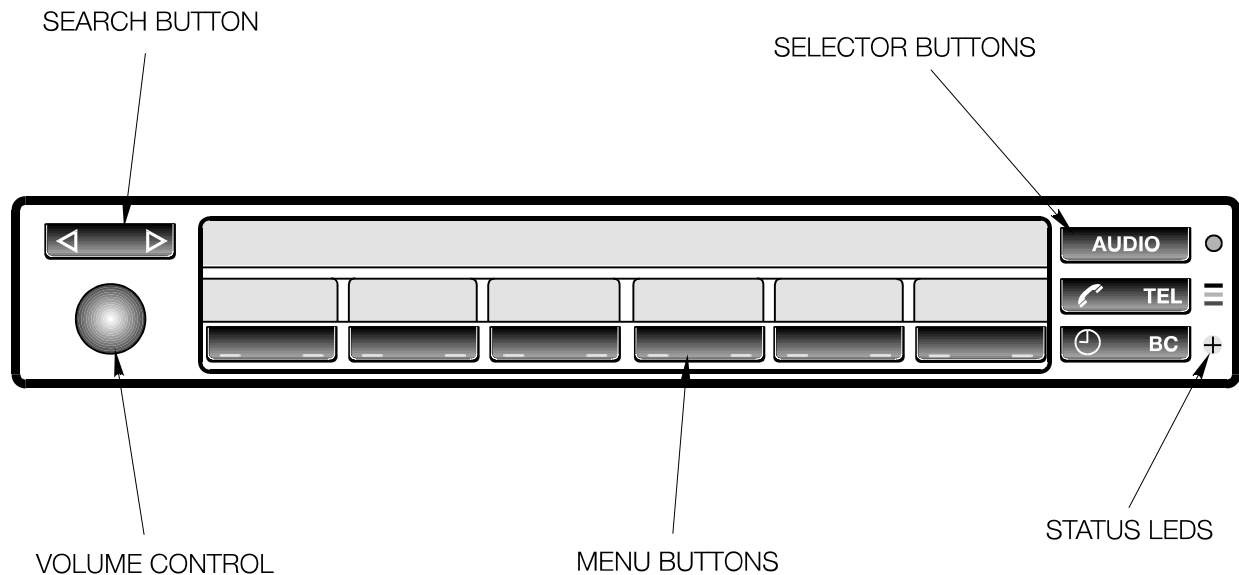

- **Volume control**
 - Push button that turns the audio system on and off.
 - Rotary knob that controls the volume of the audio system and telephone hands free speakers.
- **Status Led**
 - LEDs that are red, yellow, green for signaling the status of the telephone.
 - A red fan symbol that signals to status of parked car ventilation.

Because of the increase in size of the main display, information from more than one system can be displayed at the same time i.e. radio station and time.

MID Self Test

The MID test function is activated by pressing the first and last menu buttons while switching the ignition on. The following items can be tested.

Unit Identification - This information appears for approximately 3 seconds when the ignition is switched on. The ID information displayed is:

- Hardware number
- Software number
- Variant index

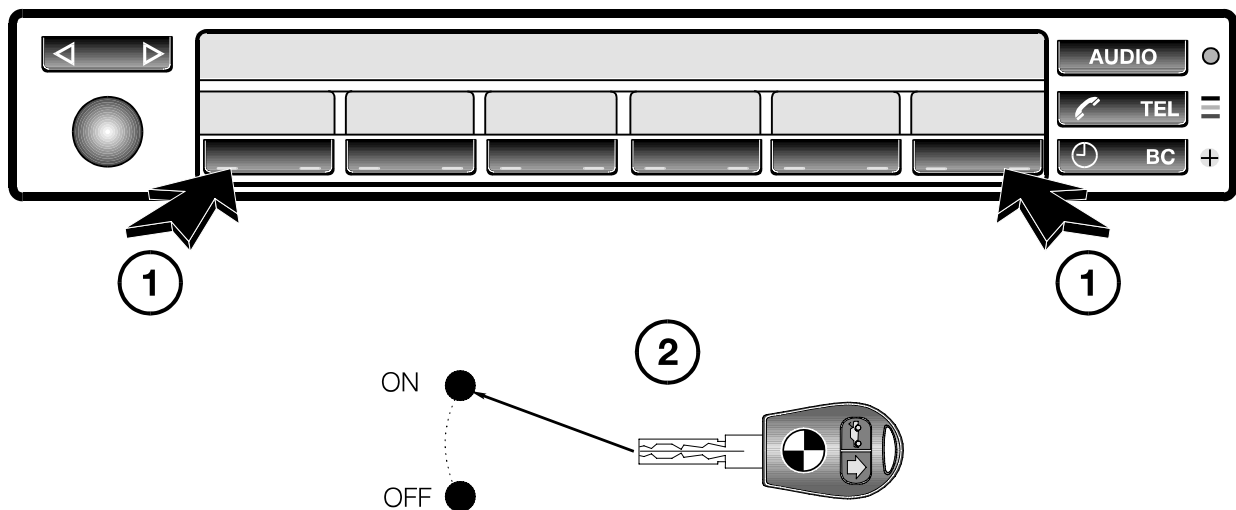

All other test functions must be activated while the ID information is displayed. If this is not done, the MID test is cancelled after the ID information is posted.

Display Test: Activate this test by pressing the display menu button. All elements of the main and menu displays are illuminated with different check patterns.

Button test: Start the test by pressing the button test menu button. All the buttons on the MID have been assigned an alphabetical letter that will appear when the button is pressed.

Volume control test: The test is carried out by pressing the menu button and turning the volume knob. Numbers from 01 to 36 appear on the display indicating each step of knob rotation.

Status LED test: Activate the test by pressing the menu button. All status LEDs are illuminated.

On-Board Computer (BC)

The processing and display of the on-board computer functions is carried out by the IKE.

The IKE receives and evaluates all of the BC required data. The BC functions can be called UP for display on the MID or the Instrument Cluster matrix.

The following BC functions are available for display.

- Time
- Date
- Average speed
- Range
- Distance
- Arrival Time
- Average fuel consumption
- Limit
- Timer/Stopwatch
- Code

The outside temperature measurement is not a BC function. The temperature is continuously displayed in the instrument cluster and is used to activate the freeze warning.

BC OPERATION

Operation and programming the BC functions has changed to suit the new MID layout.

Entering time/date

1. Press clock button
2. Set time with menu buttons
3. Press set button to start the clock

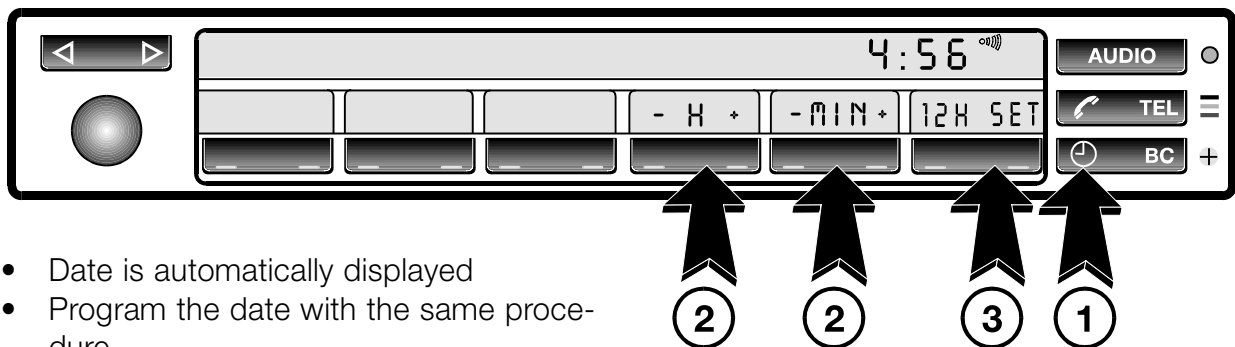

- Date is automatically displayed
- Program the date with the same procedure.

Reset time

1. Call up clock with clock button
2. Press clock button again
3. Press the "Set" button
4. Reset time
5. Press set button to restart clock

Reset date

1. Press the clock button twice
2. Select the date function
3. Press the "set" button
4. Reset the date
5. Press "set" button to acknowledge the new date

The remaining BC functions can be displayed by pressing the BC button. Each function is called up by pressing its menu button.

Programming functions

- Call up functions to be programmed
- Using menu button
- Press “set” button - menu switch to numbers for entering data
- Program function
- Press “set” button to acknowledge data

Resetting non-programming functions

- Call up function using menu button
- Press “set” button - function is reset

Change over button: The change over button is the left toggle of the set button.

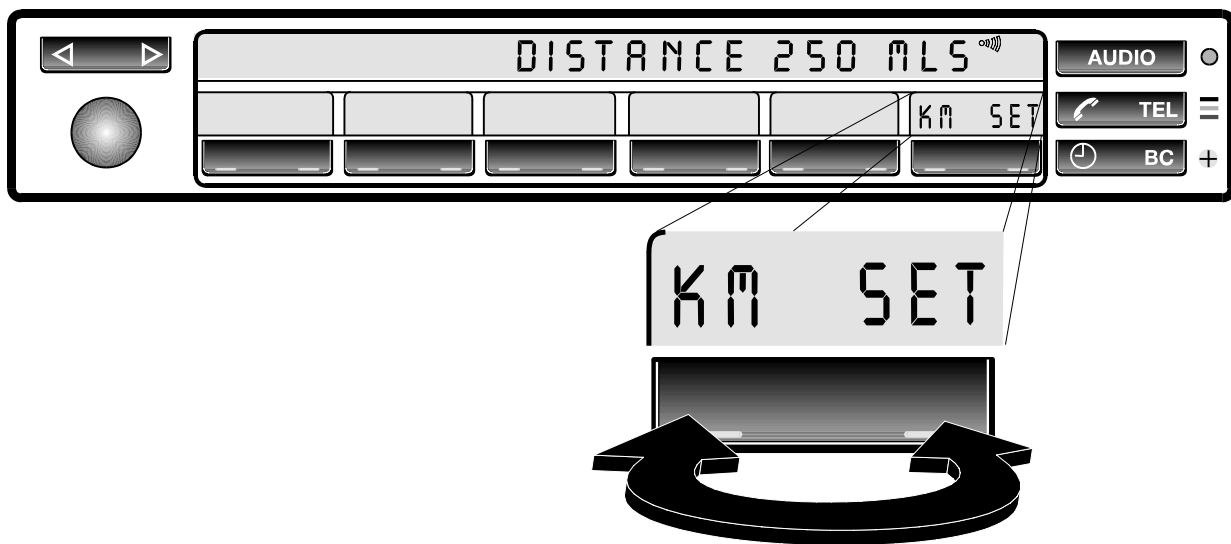

- **12H OR 24H** is displayed in the change over menu when resetting the time. Pressing the button will change all time calculations between a 24 hour and 12 hour clock display.

The date change over is activated with the clock change over. A 12 hour clock yields a month/day/year date display.

- **MLS OR KM** is displayed in the change over menu when a distance or speed function is called up. Pressing the button will change all distance between kilometers and miles readings and speed.
- **MPG OR L/KM** is displayed in the change over menu when a consumption function is called up. Pressing the button will change both consumption displays at the same time.

BC information can be displayed in the instrument cluster by pressing the remote switch on the end of the turn signal lever. The matrix display is blacked out when the remote switch is pressed after the last function is posted. The order and quantity of functions to be displayed in the instrument cluster can be programmed.

- 1. Press and hold remote switch until “Prog 1” appears in both displays. The programming feature is now active.
- 2. Use MID buttons to select functions to be displayed in the cluster. The function title appears in the MID.
- 3. The programming function is acknowledged by pressing the “set” button on the MID.



E39/E53 Multi-Information Display (MID)

Both the E39 and E53 not equipped with Navigation will use the MID for control and display of the radio/tape/CD changer and On-Board computer.

If installed, the Digital Sound Processor (DSP) will also be adjusted and controlled through the MID.

The MID does not perform any calculations, it is only an input/display device.

The MID contains two sets of displays:

MAIN DISPLAY - A 32 character display for presentation of primary information.

MENU DISPLAY - 6 small display blocks above each button switch for labeling the switch functions.

HIGH VERSION FOR USE WITH HIGH CLUSTER

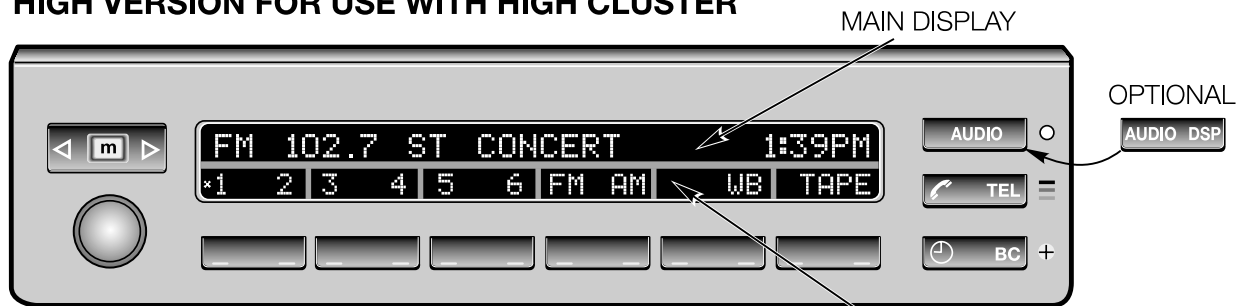

BASE VERSION FOR USE WITH BASE CLUSTER

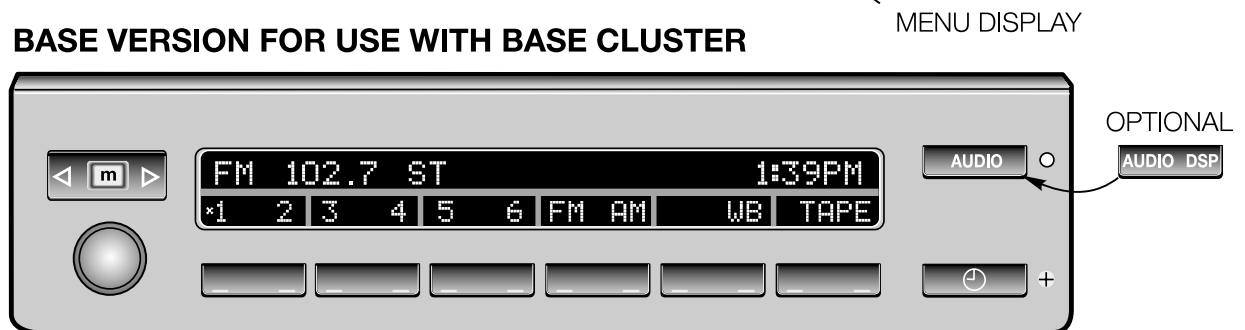

Note: The Telephone button is installed on Base version MID's as of 3/97 production.

MENU BUTTONS - the buttons are designed as rocker switches having a left and right side contact. The function of each button changes as the different systems are selected.

SELECTOR BUTTONS - These buttons are used to select the desired system to be used

- **Audio** - calls up the radio/tape/CD control functions for operation and programming.
- **Telephone** - used to program and call up stored telephone numbers.
- **Time/BC** - calls up the clock and BC control functions for programming and display.

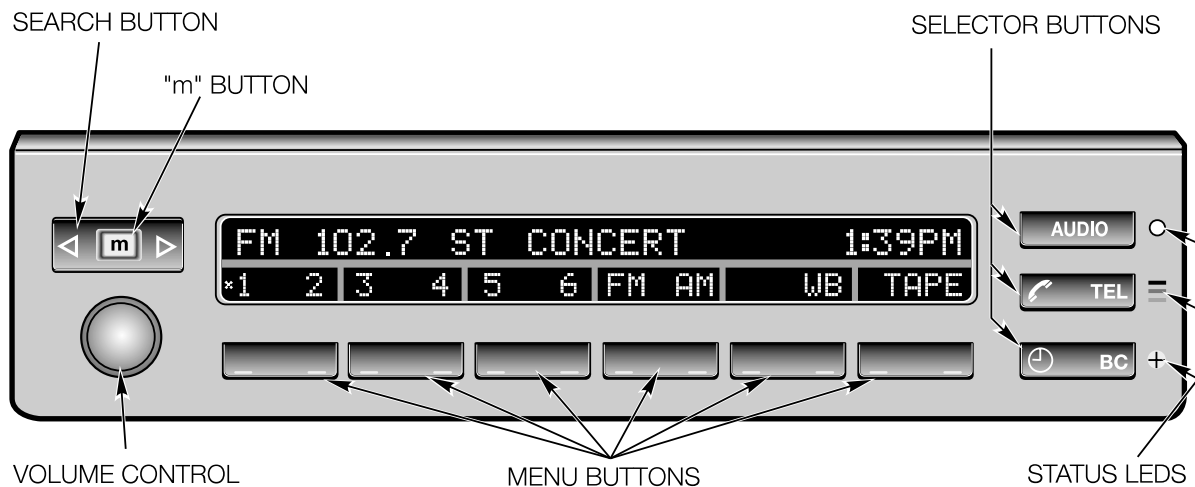

SEARCH BUTTON -

- **Radio** - will activate the search for radio stations in either direction
- **Tape** - activates music search in forward or reverse directions.
- **CD** - activates title search up or down the music list.

The integrated “m” button is used to switch over to a “manual” search of the functions listed above. An “m” is posted in the display when in this mode. The “m” button is also used to activate the radio test.

VOLUME CONTROL

- Push button for ON/OFF control of audio system.
- Rotary knob for volume control on the audio system and telephone hands-free speakers.

STATUS LEDs

- Red, yellow and green LEDs indicate status of telephone operation.
- A red fan symbol indicates the status of the parked car ventilation system’s operation.

MID Self Test

Operation of the MID can be checked through the test function sequence on the MID panel.

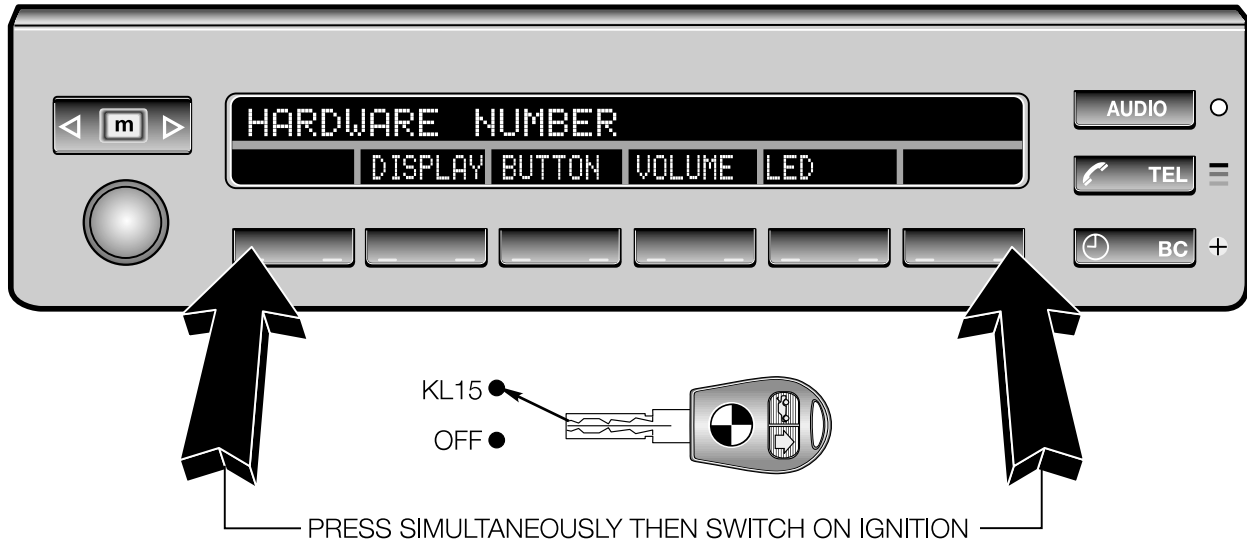

The following items can be checked:

UNIT IDENTIFICATION - The following information appears for approximately 3 seconds when the ignition is switched on

- Hardware number
- Software number
- Variant index

All other test must be started within three seconds, while the identification data is displayed. If not the MID will exit the test mode.

DISPLAY TEST - Activate this test by pressing the display menu button. All elements of the main and menu displays are illuminated with different check patterns.

BUTTON TEST - Start this test by pressing the button test menu button. All buttons on the MID have been assigned an alphabetical letter that will appear when the button is pressed.

VOLUME CONTROL TEST - This test is carried out by pressing the volume menu button and turning the volume knob. Numbers from 01 to 36 appear in the display indicating each step of the knob's rotation.

STATUS LED TEST - Activate this test by pressing the menu button. All status LEDs are illuminated.

MID Removal

The E39/E53 MID is removed from the center console as follows:

1. Pull the volume knob off the MID.
2. Insert a T10 torx wrench into the recessed hole beneath the volume knob shaft.
3. Turn the wrench 90° to the left until a stop is felt.
4. While maintaining tension on the wrench in the stopped position, use the torx wrench as a pull handle to pull the left side of the MID out of the center console. The right side of the MID acts as a hinge on the center console.

The radio/tape player is removed by turning the 2.5mm allen head bolts to unlatch it from the center console as on previous radios. The radio allen head bolts are visible once the MID is removed.

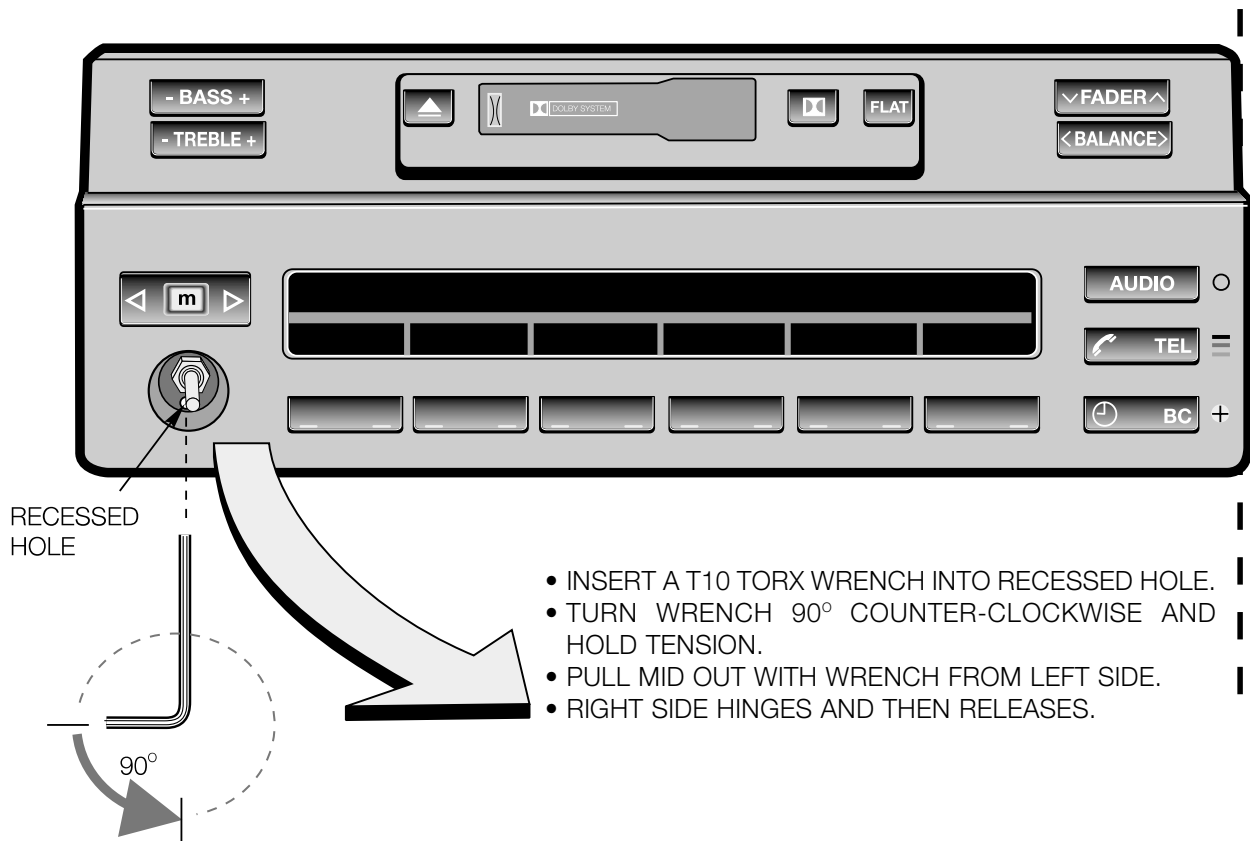

On-Board Computer (High version)

The BC processing is a function of the IKE and can be displayed in the cluster matrix display or on the MID.

The following BC functions are available for display:

- Time/Date
- Distance
- Limit
- Arrival Time
- Stop Watch
- Average Speed
- Code
- Range
- Average fuel consumption
- Two Timers for programming parked car ventilation



Operation and programming of the BC is carried out with the MID.

The menu displays change as each function is called up for programming/resetting purposes. this includes the changeover functions for the clock, mileage and MPG displays.

BC functions can be displayed in the cluster matrix by pressing the turn signal lever as in the past.

The cluster displays can be programmed for number of displays and order of appearance.

Setting a code with the BC will override the EWS cancellation of the drive away protection when the correct key is used.

An emergency deactivation is possible for the CODE function. A 10 minute wait time is required after disconnect/re-connection of the battery before the code is canceled.

MULTI-FUNCTION STEERING WHEEL (MFL) & CRUISE CONTROL II (GR II)

Models: E38, E39, E53

Production Date: From start of production

Objectives

After completing this module you should be able to:

- Describe how the MFL communicates signal requests to various control modules.
- Explain the changes made to the MFL since its introduction.
- Describe the operation of the heated steering wheel.
- Identify the components used in the GR II system.

Multi-Function Steering Wheel (MFL)

The MFL is a system that allows the driver to make various switching requests without having to look away from the road or remove a hand from the steering wheel.

The steering wheel incorporates the control switches for:

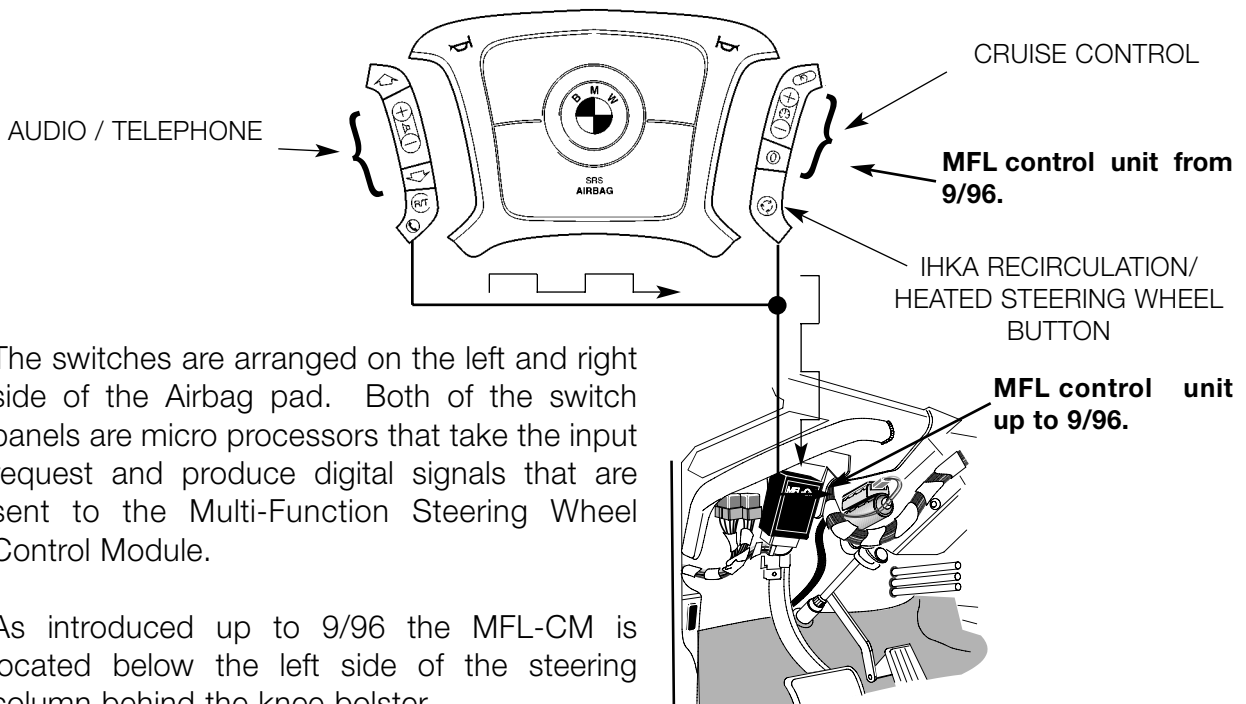

The switches are arranged on the left and right side of the Airbag pad. Both of the switch panels are micro processors that take the input request and produce digital signals that are sent to the Multi-Function Steering Wheel Control Module.

As introduced up to 9/96 the MFL-CM is located below the left side of the steering column behind the knee bolster.

After 9/96 the MFL-CM was deleted and the electronics were incorporated into the right button pad.

The input signals from the control switches are processed in the MFL and sent to the respective control modules for system operation.

The signals for the control of telephone, audio system and re-circulation operation are passed over the I/K-Bus. The signals for cruise control operation are passed to the cruise control module or DME through a separate data link from the MFL.

The MFL-CM contains a fault memory that monitors the steering wheel control switches. Diagnosis is carried out with the DIS/MoDiC.

Heated Steering Wheel

The heated steering wheel system consists of the following components:

- A heating filament integrated into the steering wheel cover.
- An NTC temperature sensor, in the filament circuit, to regulate the heating current.
- A push button mounted in the right side MFL key pad.
- The control module located behind the air bag assembly.
- Slip ring assembly for the power and ground supply.

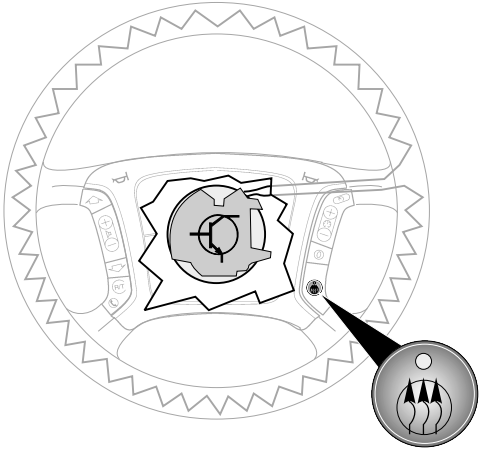

OPERATION

When KL 15 is switched ON, the heated wheel can be switched ON by pressing the button. A green LED illuminates to indicate system operation. Maximum current is supplied and heats the filament to its operating temperature (surface temperature of approximately 90°F). The NTC detects the temperature of the filament and causes the control module to cycle once the wheel is heated. Cycling is carried out with a pulse width modulated signal.

The system is not connected to the diagnostic link, however the control module does monitor operation of the system.

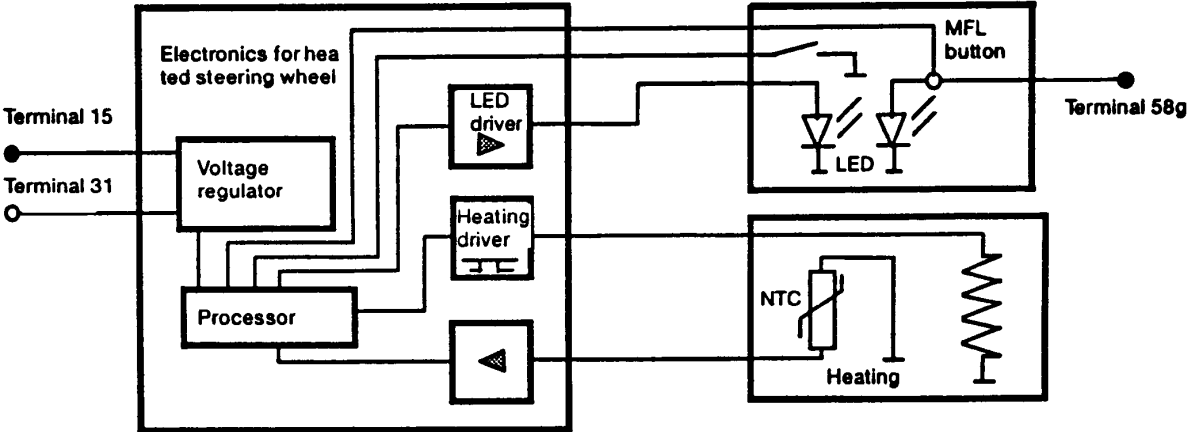

GR II (SPEED CONTROL II)

INTRODUCTION

GR II was introduced for the first time on the E38 740i. GR II is a speed control system for vehicles not equipped with EML. It is similar in operation to the former system (FGR) found on older models. It offers improved control electronics to ensure that the set speed is reached and maintained without the sensation of fast acceleration or deviations of more than 1 MPH from the set speed.

The GR II offers the following advantages:

- Fatigue-free driving over long distances with a set speed.
- The constant travel speed results in lower fuel consumption.
- By setting a speed, speed limits are observed automatically.

Like most of the other systems in the E38/E39, the GR II utilizes digital signal processing. This eliminates the amount of wiring required to achieve system operation and improves the reliability of cruise control operation.

The driver's request for cruise control functions is activated by the button pads of the MFL.

An ON / OFF main switch ensures that the cruise control system is not inadvertently engaged while driving the vehicle.

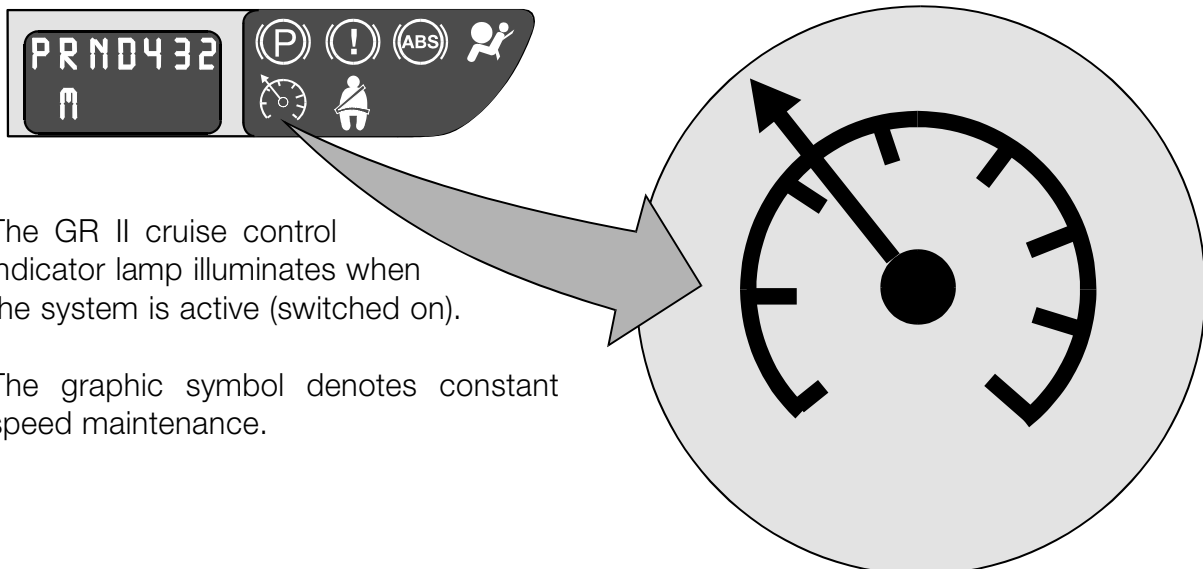

The GR II cruise control indicator lamp illuminates when the system is active (switched on).

The graphic symbol denotes constant speed maintenance.

COMPONENTS OF THE SYSTEM

The GR II system consists of the following components:

MAIN SWITCH (Up to 9/97)- The main switch is mounted on the right side of the dash panel below the instrument cluster. It produces a momentary ground signal to the GR II control module. When pressed the GR II control module switches on and the cruise enable indicator lamp in the instrument cluster (green in color) is illuminated.

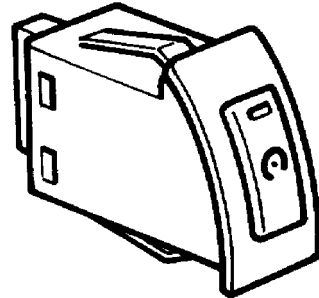

After 9/97 the main switch was deleted and combined with the “OFF” switch located on the MFL.

CRUISE CONTROL SWITCH - The cruise switch pad is

mounted on the right side of the steering wheel.

All of the request functions (SET, ACCEL, DECEL, RESUME AND OFF) are activated from the cruise switch pad.

These request inputs are processed by the switch and transmitted to the Steering Wheel Control Module (MFL-CM) over a data link.

STEERING WHEEL CONTROL MODULE -

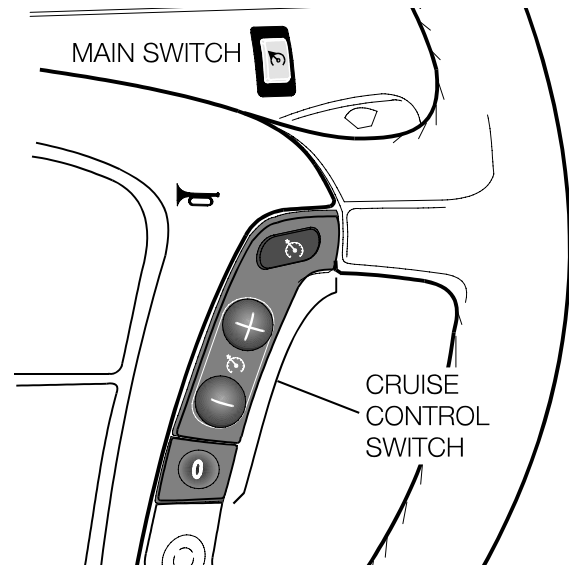

Up to 9/96 the MFL-CM is mounted on the left side of the steering column behind the left side knee bolster. After 9/96 the MFL - CM is integrated into the right button pad.

The cruise control requests are processed and transmitted to the GR II cruise control module over a dedicated data link.

CRUISE CONTROL MODULE - The cruise control module is mounted in

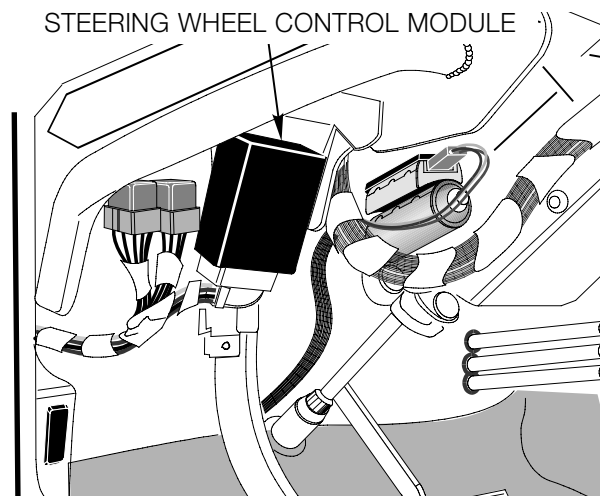

the E-box between the the DME and AGS control modules.

It has one blue 26 pin ELO type connector.
CRUISE CONTROL ACTUATOR - The cruise control actuator is mounted on the left fender well and contains the actuator

GR II CONTROL MODULE

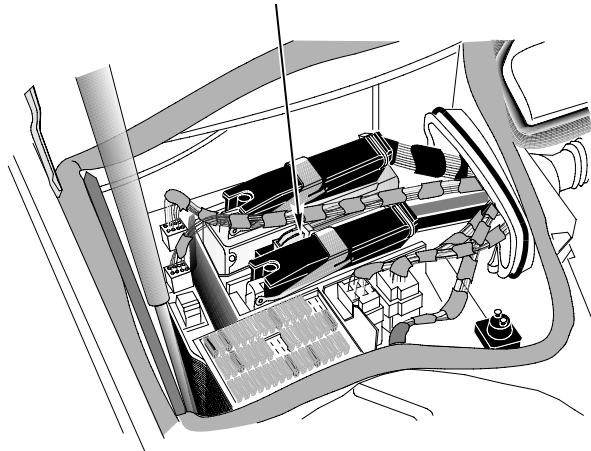

motor, feedback potentiometer and actuator clutch.

The actuator is connected to the throttle valve with a bowden cable parallel to the accelerator cable.

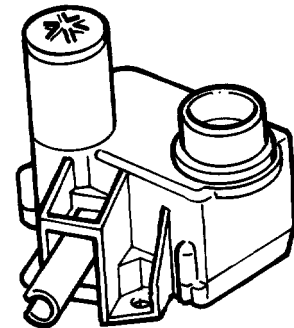

COMPONENT COMMUNICATION

The cruise control switch pad provides momentary ground signals and converts them into a dynamic digital signal.

The signal is sent to the steering wheel control module and passed through a gateway to the GR II control module.

The GR II carries out the systems functions based on this dynamic digital signal and other input signals.

The actuator is controlled by final stage activation at both sides of the motor.

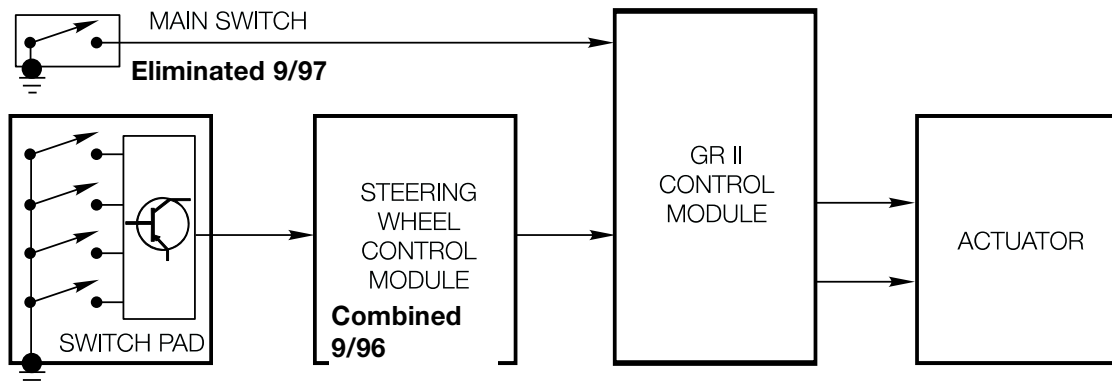

CRUISE CONTROL SWITCH OPERATION

When the main switch is turned on and the vehicle speed is above 20 mph, the cruise control can be set or adjusted at the cruise control switch pad.

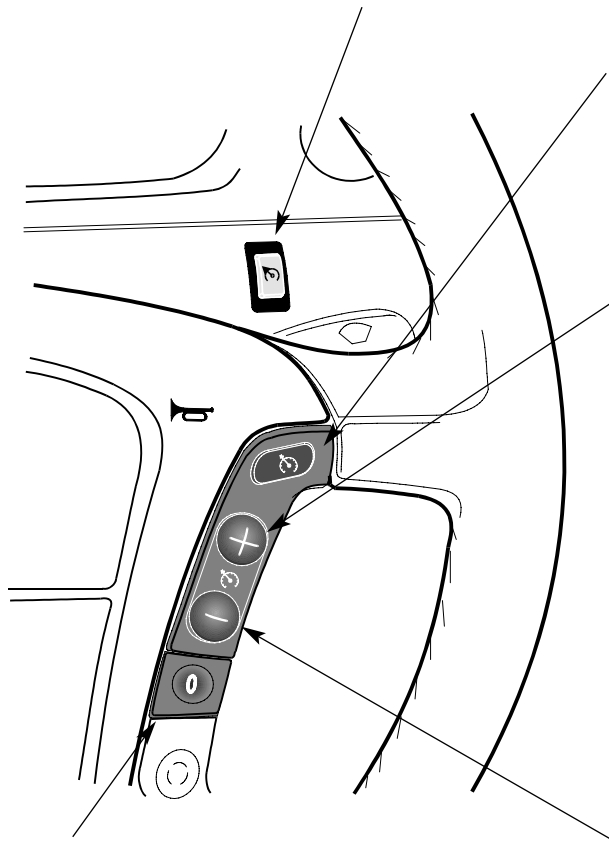

RESUME: Briefly pressing the resume button will cause the vehicle to accelerate/decelerate to the stored speed value in the cruise control module.

SET/ACCELERATE/TIP-UP: Pressing the set button will engage the cruise system and maintain the vehicle's current speed.

Pressing and holding the set button will cause the vehicle to accelerate. When released, the vehicle's current speed will be the set speed.

Tapping the set button will cause the speed to increase by approx. 1 MPH. The number of times the tip feature will function is limited to 8.

OFF: Pressing the off button will disengage the cruise control. The previous set speed is stored in memory until it is over written or the vehicle is switched off.

In addition to switching off via the cruise control switch on the steering wheel, the

DECELERATE/TIP-DOWN: Pressing and holding the decelerate button will cause the vehicle to slow down. When the button is released, the current speed is the new set speed. Tapping the button will cause the vehicle speed to decrease by approx 1 MPH. The number of times the tip feature will function is limited to 8.

system can also be switched off by:

- Depressing the main switch on the instrument panel.
- Applying the brakes.
- Shifting the transmission into neutral.

CRUISE CONTROL MODULE

The cruise control module contains control logics for smoother operation. The control logics prevents the maximum acceleration/deceleration feel that was characteristic with the earlier FGR system.

The rate of acceleration in SET ACCELERATE and RESUME is based on the current road speed of the vehicle. The rate of acceleration is high at low vehicle speeds and gradually decreases as vehicle speed increases. This gives the feeling of steady smooth acceleration.

The rate of deceleration when the DECELERATE button pressed is linear until the throttle valve closes. The decel rate is then dependent on the engine braking effect and road conditions. This results in a smooth speed reduction.

If the set speed can not be maintained due to unusual operating conditions (severe up hill grades), the control module adopts a special resume mode. Once the unusual operating condition is overcome, the set speed will be resumed at a reduced acceleration rate. This feature is designed to prevent a sensation of rapid accelerating.

The cruise control module is connected to the AGS control module through a data link. When cruise control functions are activated, the AGS shift program is adapted to match the requirements of the requested cruise control function. For example, when the GR II is set at a specific speed and a severe down hill grade causes the vehicle to overcome the set speed the GR II signals the AGS to downshift a gear. This will occur as needed to maintain the set speed as closely as possible.

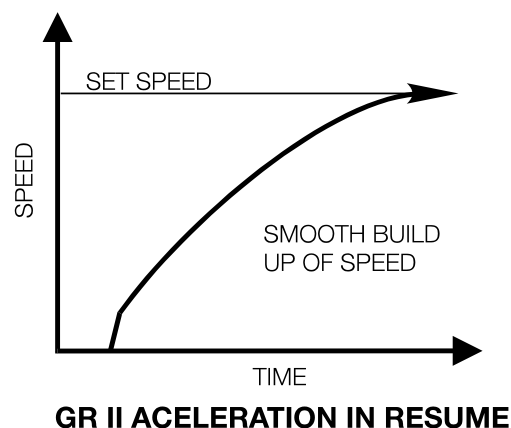
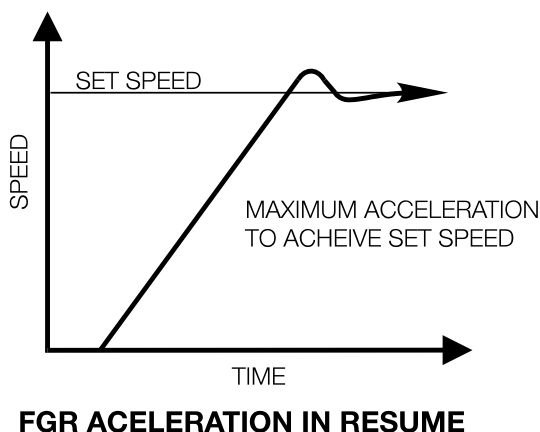

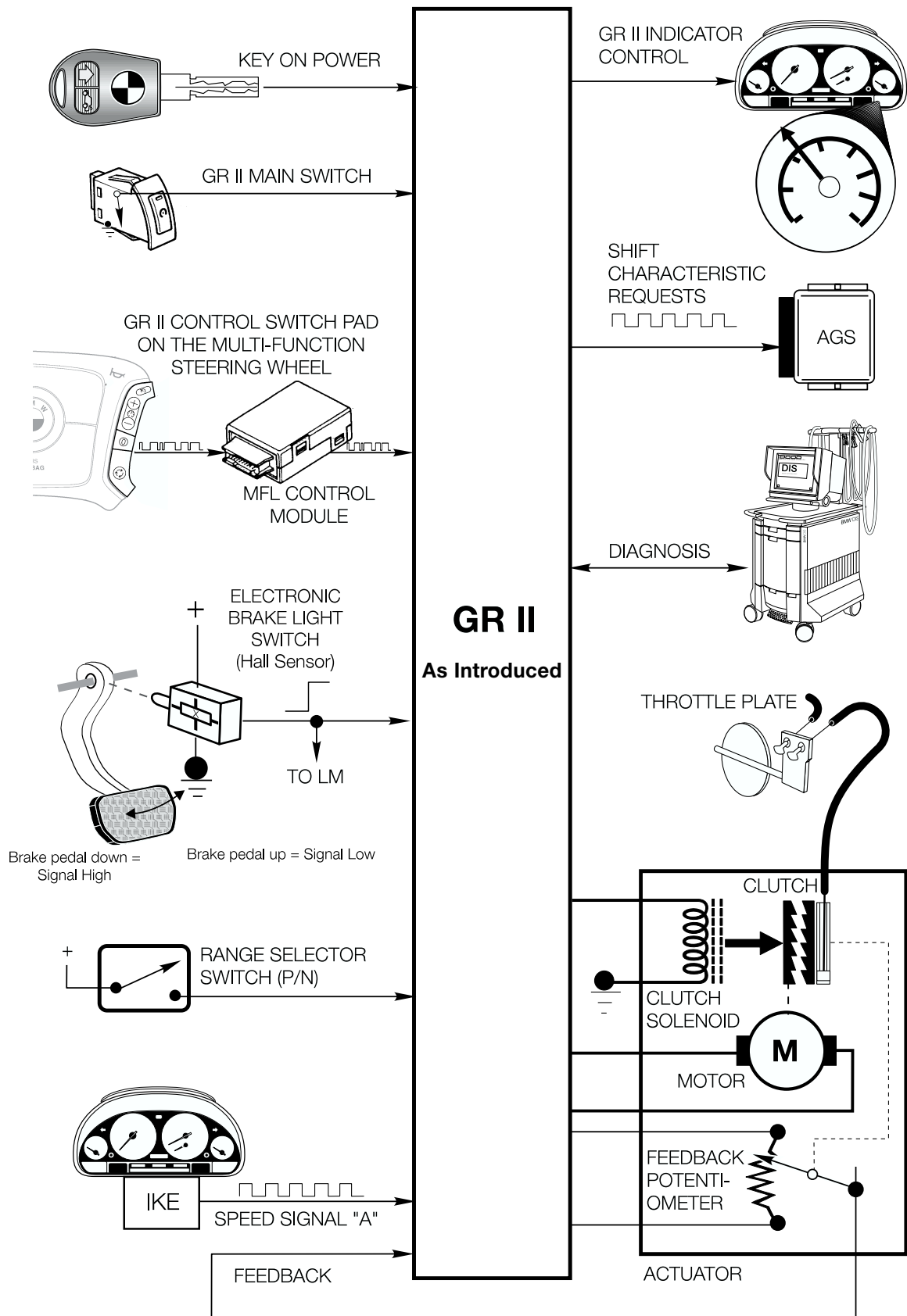

PLAUSIBILITY/SAFETY FEATURES

To avoid malfunctions or unsafe conditions, the GR II continuously monitors the input and output signals. Redundant (or dual signal) processing ensures that the input signals are plausible and prevents unsafe cruise control operation from being carried out. The following safety measures are also included in the total scope of cruise control operation.

- Minimum speed - The minimum speed threshold for cruise control operation is 30 km/h (approx. 20 MPH). If the speed drops below this value the cruise control will not operate.
- Shut off priority - The brake pedal and transmission neutral switch have priority for switching the system off. If a malfunction caused several commands to be called up at the same time, the brake switch signal would disengage the system.
- If the set speed is exceeded by more than 8km/h (approx. 5MPH), the system will disengage by the actuator clutch. When the speed drops below the threshold, the clutch will re-engage and the cruise will continue operation.
- The data link from the cruise control switch is continuously checked for signal integrity.

DIAGNOSIS/ENCODING

Diagnosis of the GR II system is carried out with the DIS tester. The cruise control module stores faults that occur with the input/output signals for cruise control operation. The Multi-Function steering wheel control module stores faults that occur with the cruise control switch.

There is only one control module for all model versions that use the new GR II system. Encoding is required if the control module is changed. To code a new control module, go to the coding application in DIS and carry out a coding procedure as stated on the screen.

An uncoded module will allow limited cruise control operation.

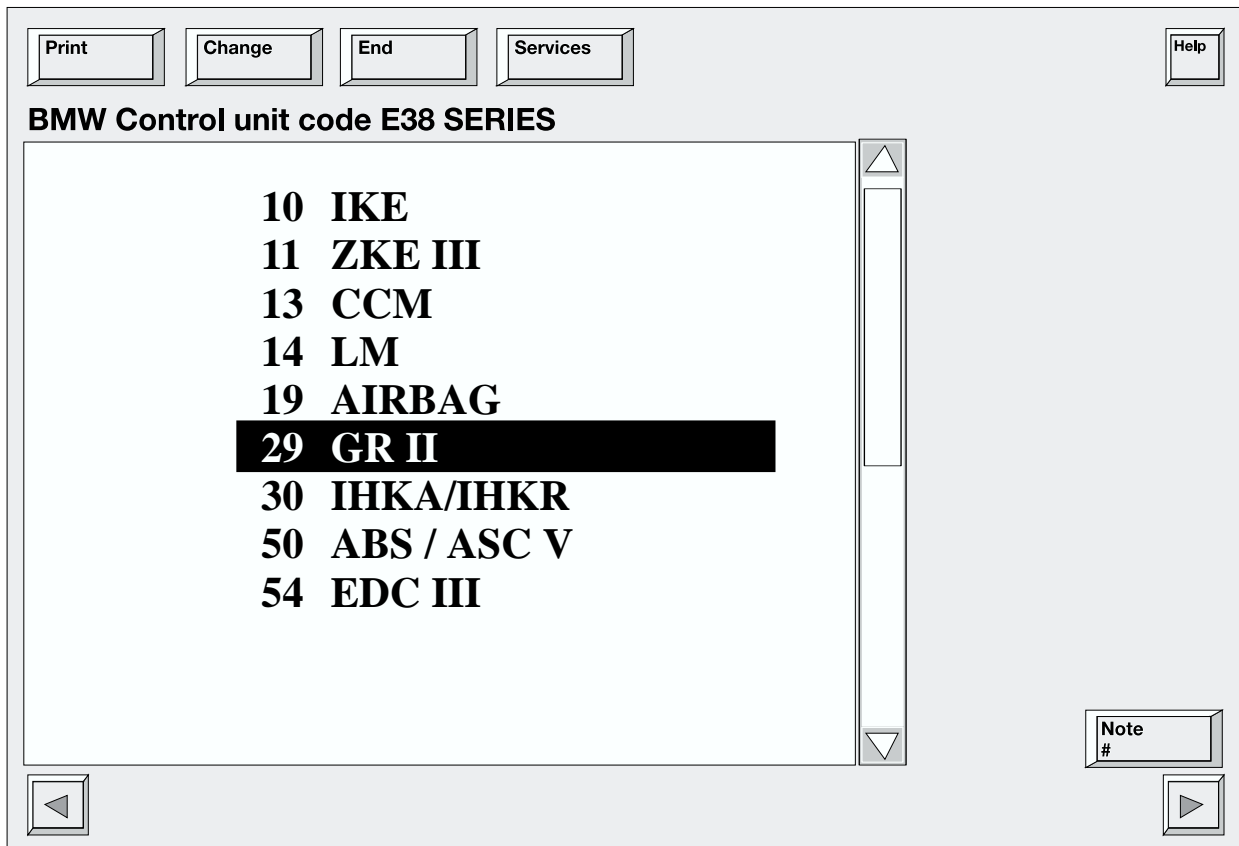

AUDIO SYSTEMS

Models: E38, E39, E53

Production Date: From production start

Objectives

After completing this module you should be able to:

- Recognize the various methods of controlling the audio system.
- Know how to perform the radio self-tests.

Audio Systems

E38 without Board Monitor:

- **MID** - for ON/OFF, Volume control, Station select and Station presets.

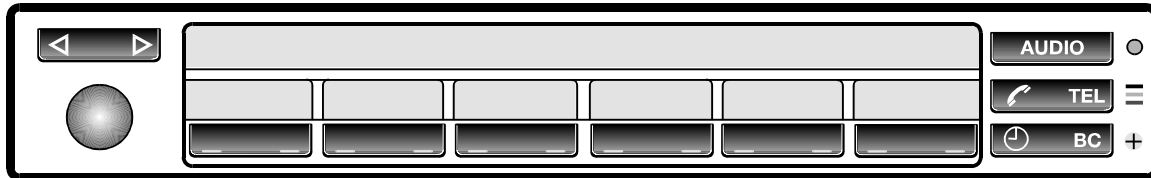

- **Radio/Tape player**- houses radio electronics, tape player, Treble/Bass/Fader/ Balance adjustments.

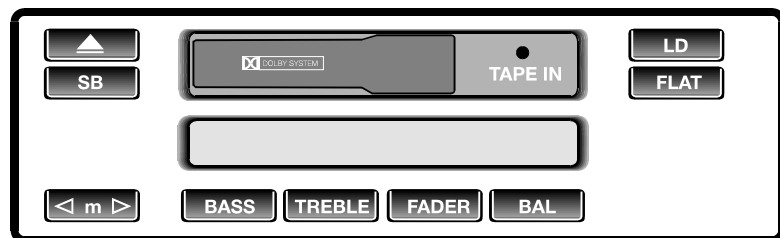

- **Amplifier** - mounted in the trunk.
- **Digital Sound Processor with Amplifier** (if installed) - for setting the sound quality (concert hall, jazz club, cathedral or user selected settings).
- **CD player** (if installed) - mounted in the trunk.
- **Speakers** - 10 with standard sound system.
- 14 with DSP system.
- **MFL controls** - mounted on the steering wheel.

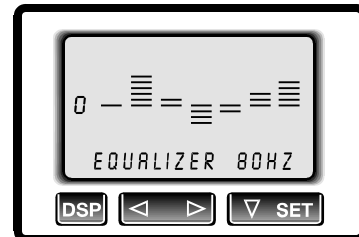

The radio/tape player deck contains the electronics for radio/tape operation. The ON/OFF-volume control and station display are incorporated into the MID. This configuration renders the radio useless if stolen from the vehicle. **The radio is not coded.**

The main control for radio operation can be carried out from the MID or the steering wheel controls. The secondary controls are incorporated into the radio/tape player.

If installed, the Digital Sound Processor / Amplifier (DSP) is an electronic graphic equalizer that can adjust the sound quality (spatial simulation) of the audio system. The DSP has three preset sound amplification modes. These include:

- CONCERT HALL
- JAZZ CLUB
- CATHEDRAL

Selecting one of these settings will adjust the sound amplification and reverb from the speakers to simulate the selected listening mode. There are also three driver selected modes that the driver/passenger can use to set the sound amplification to their own liking.

All control and adjustment of the DSP is carried out through the three control buttons located on the face of the DSP.



DSP Button - is used to turn the DSP ON/OFF



Right/Left arrow button - is used to select the listening mode and adjust the reverb, room size simulation and levels of the graphic equalizer bands.



Down arrow/Set button - is used to select and activate the various adjustments and acknowledge the set inputs.

All adjustments and modes are displayed on the face plate of the DSP. This includes a menu line to display the current mode or adjustment. Once the DSP is set and a listening mode is activated, the face plate of the DSP remains blank.

Any listening mode can be turned ON/OFF, any time the radio is on, by pressing the DSP button.

The DSP is an available option that cannot be retro-fitted to the vehicle. The system includes a different wiring harness, DSP amplifier and speakers for audio system operation.

The DSP control panel and DSP amplifier are connected to the I-Bus for data communication with the audio system.

RADIO TEST FUNCTIONS

With the ignition switch in KL R the radio can be switched into the test function mode by pressing and holding the WB (weather band) until the MID displays a serial number in the MID main display.

The test functions include:

- Radio serial number,
- Radio Production Date
- DSP Recognition
- Road speed dependent volume control (GAL 1-4)
- Station signal strength

The road speed dependent volume control can be adjusted to make the volume increase more audible (4) or less audible (1).

E39/E53 audio system without Board Monitor:

- **Radio/Tape player** - houses radio electronics, tape player, treble, bass, fader, balance adjustments.

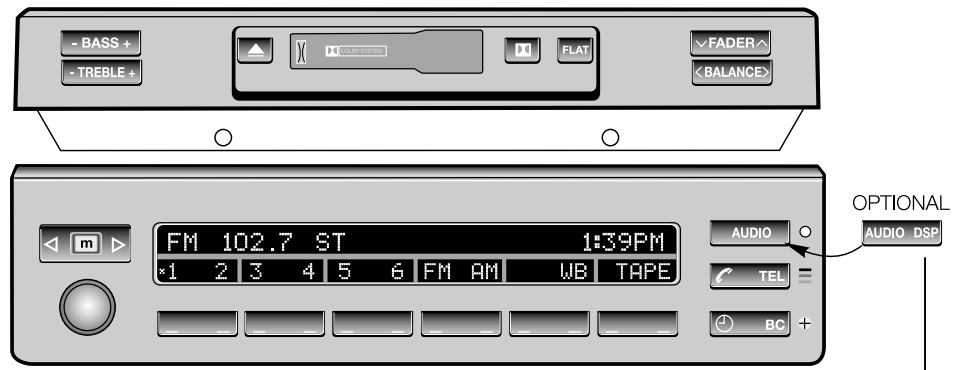

- **MID** - for ON/OFF, volume control, station selection, digital sound processor (DSP) control, etc. If the DSP system is installed, the audio button in the MID has a second position to activate the controls.

Except for the number of memory positions for DSP programming, all of the features of the separate E38 DSP switch panel are incorporated into the MID. The memory feature of the E39 DSP has two memory positions whereas the E38 has three.

- **Amplifier** - Mounted in the trunk.
 - The standard 200 watt amplifier for the 10 speaker non DSP audio system
 - The optional 12 speaker 440 watt amplifier for the 12 speaker DSP audio system.
- **CD Player** - mounted in trunk if installed.

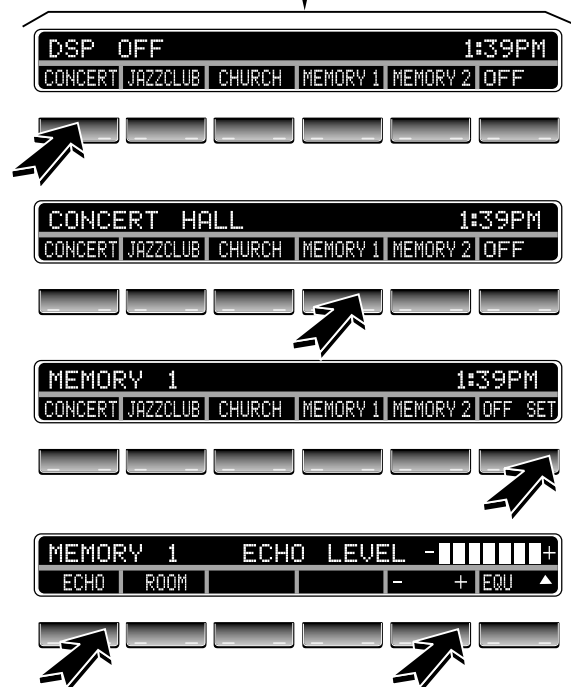

MFL Controls

RADIO TEST FUNCTION: To activate the test, switch the radio on and within 8 seconds press and hold the “m” button for more than 8 seconds. The displayed tests include:

- Radio Serial Number
- Radio Production date
- DSP Recognition (1/0)
- Station signal Strength
- Road speed dependent volume control (GAL 1-4)

Adjusting the GAL makes the volume increase more noticeable (4) or less noticeable (1).

“NEW GENERATION” (NG) RADIOS

Model: E39, E46, E52, E53

Production Date: Starting from 9/00

Objectives

After completing this module you should be able to:

- Recognize the new features of the “NG” radios.
- Identify the components that interact with the radio system.
- Describe the features of the MIR.
- Review how to access the radio service mode.

Introduction

Starting September 2000, a family of new generation radios will begin to be phased into production. The exception to this is the E52 which has been available with the MIR (multi-information radio) NG radio since series launch in mid 2000.

The NG “New Generation” radios will have increased functions:

- Radio can be operated without KL R.
- Radios are world frequency.
- Car memory programming.
- Audio mixing on vehicles equipped with navigation.

The radios external appearance has not changed. NG radios can be identified by their “53” designation.

Overview of the Radios for Each Model

RADIO	TYPE	MANUFACTURER	MODEL	INTRODUCTION DATE
C53	Business with cassette	Philips	E46	3/01
CD53	Business with in-dash CD	Alpine	E46	3/01
C53	Business with MID control and cassette	Phillips	E39/E53	9/00 E39 10/00 E53
CD53	Business with MID control and in-dash CD	Alpine	E39/E53	9/00 E39 10/00 E53
C53	Business MIR without cassette	VDO	E52	Start of production
BM53	Business with BM control	Becker	E46/E39/E53	03/01 E46 02/01 E39 04/01 E53

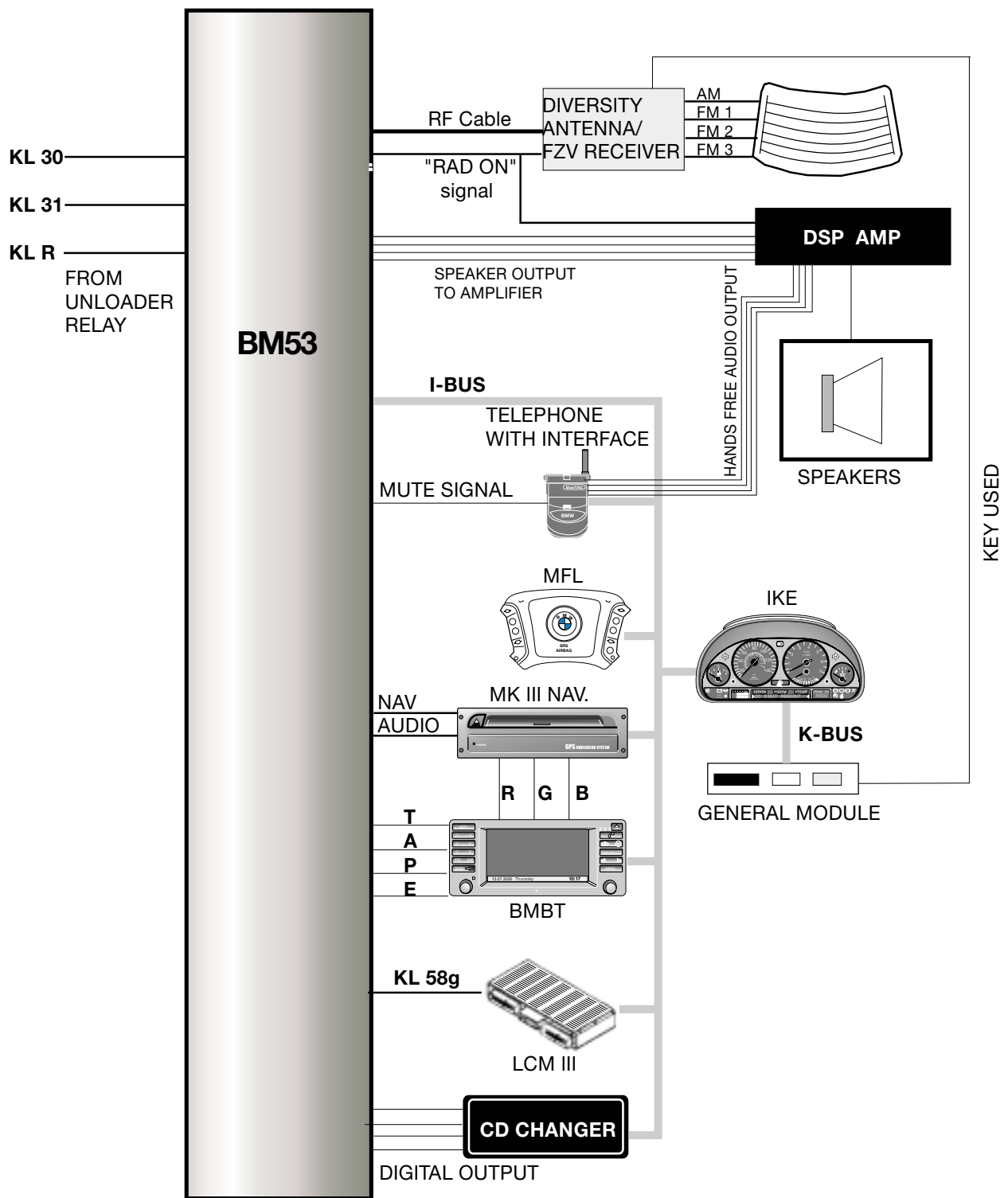

NG Radio System Overview
Example: E39 with MK III navigation and BMBT

Functional Overview

NG Radios

Radio Operation with KL R off

Operation is possible with the key off on the C53 and CD 53 radios. If the radio is turned on with KL R off, it will operate for 16 minutes until the General Module sends the sleep command. The radio can be turned on and off as many times desired.

Diversity Antenna

Antenna diversity has been adapted to the new generation of radios. When the radio is in operation, the diversity control unit is activated by the "RAD ON" signal.

World Frequency Radio

Radios on vehicles sold in the U.S. are world radios. Specific country settings can be made using the service mode. The settings are stored in an EEPROM.

Car Memory

If programmed, when locking the vehicle using the remote transmitter the:

- last station
- Volume setting
- Last audio mode (Tape, FM, CD etc.)

are stored according to the key number used. Unlocking the vehicle with the same transmitter will restore the settings. There is a maximum setting for volume which may be lower than the setting when the radio was last operated.

Clock

Time can also be displayed when KL R is off by pressing the clock button on the Radio/MID.

Backlighting

The LCM/LSZ produces two signals for the control of radio backlighting.

- Hardwired KL 58g
- Lights on/off over the K/I Bus.

The radio contains a photo-cell for adjustment of backlighting to ambient conditions.

Reset and Voltage Monitoring

A radio reset is triggered by under voltage or the internal processor monitor. The reset function restarts the radio, similar to turning it off and back on again. Operating voltage is measured at the KL 30 input. The radio is switched off if the system voltage exceeds 17V to protect the radio, it will switch on when the voltage falls below 16V.

GAL (Speed Dependent Volume)

The speed signal from the IKE/KOMBI is available to the radio over the K/I Bus. GAL is not a feature on vehicles equipped with DSP.

Bus Communication

The radio communicates with other modules via the K bus or I Bus dependent on the model. The information shared over the bus line includes:

- **IKE/KOMBI** - Terminal status (KL 15, KL R)
- **LCM/LSZ** - Lights on
- **IKE/KOMBI link to TXD** - Diagnosis
- **MID or BMBT** - button or rotary knob status.
- **GM** - Key used to lock or unlock vehicle
- **MFL** - audio controls status

NG radios do not use anti-theft codes. Operation of the radio is only possible if connected to a bus line and the detection of at least one other component.

Multi Information Radio (MIR)

The Multi-Information Radio (MIR) is used in the E52 Z8 and is the first of the NG series of radios. The MIR contains the radio receiver, display screen, and control panel all in one unit. A cassette player is not included.

The MIR is used to control and display the:

- GPS-Navigation System
- Audio system including CD Changer
- Telephone
- Outside temperature

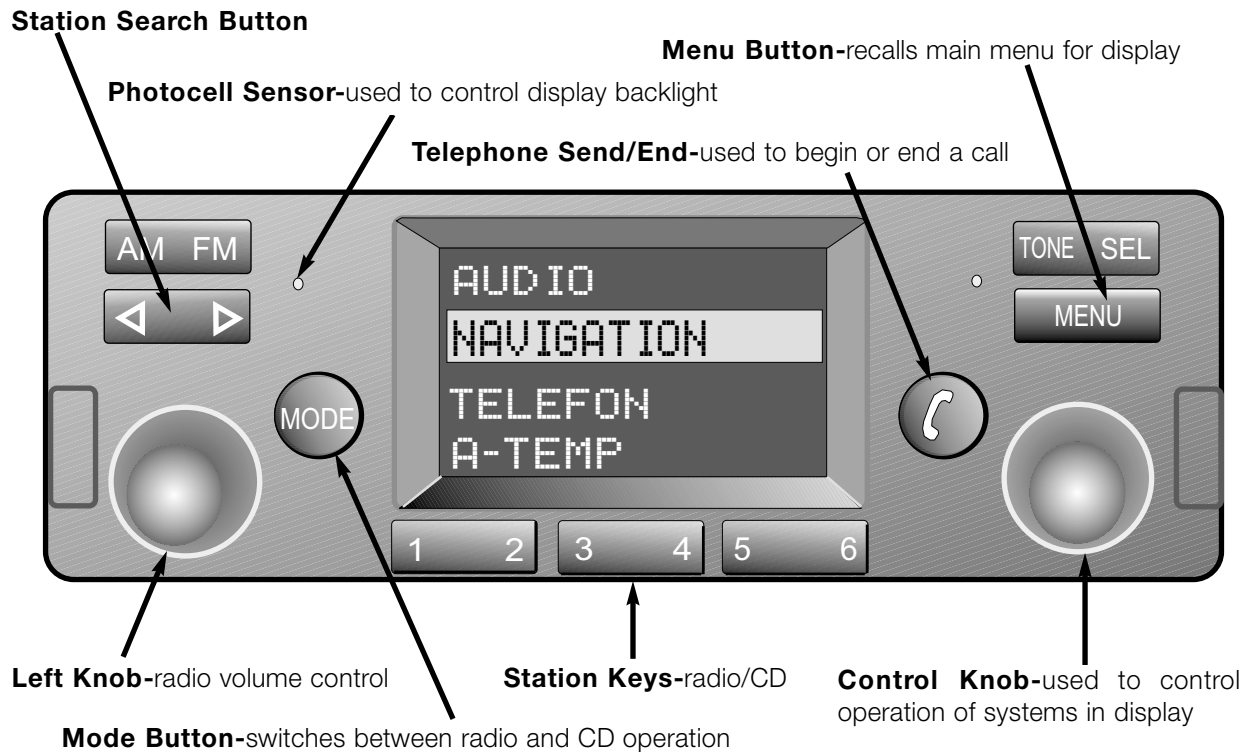

Every time the MIR is switched on it looks to see if a navigation computer is installed and displays the correct menu options. Text and symbols on the display are generated by the navigation computer and transmitted to the MIR via the "Navigation" Bus. If the MIR does not detect that a navigation computer is connected, the MIR itself will generate its own display signals. The screen display is monochrome only.

The navigation elements of the MIR will be discussed in the MK3 module.

Audio Mixing

Audio mixing allows the vehicle passengers to listen to navigation instructions without muting the radio or CD player.

On-Board Computer Functions

Outside temperature is the only on-board computer display possible for the Z8.

Workshop Hints

Service Mode for NG Radios

A service mode is available as on previous radios as a diagnosis tool and for changing radio settings. Entering the service mode varies by the device used to control the radio.

To enter the service mode:

C53/CD53 with and without MID:

- Turn on the radio.
- Within 8 seconds, press and hold the “m” button for 8 seconds.
- Scroll through functions using the “+” and “-” keys or the station < > search buttons.
- Turn off the radio to end the service mode.

C53 MIR:

- Turn on the radio.
- Within 8 seconds, press and hold the “SEL” button for at least 8 seconds.
- Scroll through functions using the station < > search buttons.
- Turn off the radio to end the service mode.

BM53 with board monitor:

- Turn on the radio.
- Press and hold the “RDS” button for at least 8 seconds.
- Scroll through the functions using the station < > search buttons.
- Turn off the radio to end the service mode.

BM53 with Widescreen board monitor:

- Turn on the radio.
- Within 8 seconds, press the “INFO” button.
- From the info screen select RDS
- Press and hold the BM control knob for at least 8 seconds.
- Scroll through functions using the station < > search buttons.
- Turn off the radio to end the service mode

Service Mode Functions

- 1. Serial Number:** Display of the radio serial number.
- 2. Software version:** Display of the radio software version. Displayed as (calendar week, year, version)
- 3. GAL:** Speed-sensitive volume control. Can be adjusted from level 1-6 using the 6 pre-set audio buttons. Vehicles equipped with DSP do not use this feature.
- 4. Field strength and Quality (F/Q):** The station currently displayed can be assessed for field strength and quality. An “F” (i.e. F15) number is used to indicate the strength of the signal being received by the radio. This is a good test of the antenna system, station signal, and the radio itself. A “Q” (i.e. Q-00) number is used to determine the quality of the radio station including both the audio and RDS signal if applicable.
- 5. DSP:** This function provides information about whether the vehicle is fitted with DSP. The value is displayed as a one (fitted) or zero (not fitted) and is communicated by the DSP amplifier via the I/K bus.
- 6. TP Volume:** Provides adjustment for traffic report minimum volume. Not used in the US.
- 7. AF:** Alternative Frequency tracking setting. Not used in the US.
- 8. Area:** Used to select the appropriate market setting (USA, Canada, Europe, Japan and Oceania). Adjust using the pre-set buttons.
- 9. Index:** Display of the revision index.

PARK DISTANCE CONTROL (PDC)

INTRODUCTION

The Park Distance Control is a safety/convenience system that uses ultra-sonic sensors to detect the close proximity to other objects when maneuvering the vehicle in tight spaces (such as parallel parking or parking in a narrow garage).

The PDC monitors both the front and rear of the vehicle. The driver is warned, through an audible gong system, when the vehicle comes close to another object. As the object gets closer, the audible gong increases in frequency until a steady tone is produced.

As the distance to the object increase, the steady tone will return to a beep and stop when the vehicle moves away from the object.

The PDC is automatically switched “ON” when the ignition is switched on. However it does not become active until the vehicle is shifted into reverse.

The system can be manually switched “ON/OFF” with the console mounted switch.

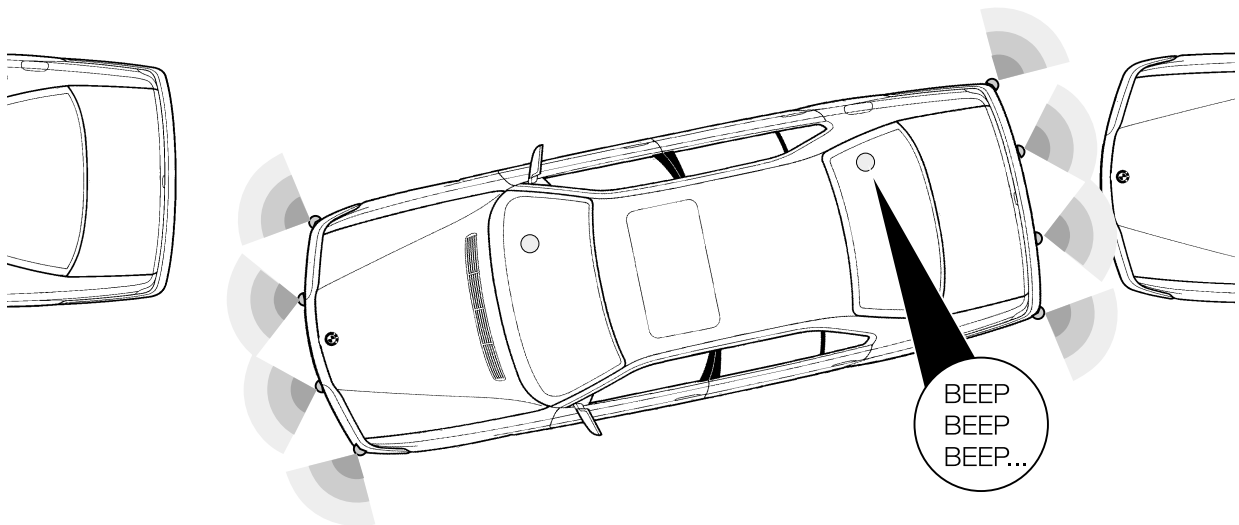

PDC COMPONENTS

The PDC system consists of the following components:

PDC Control Module - Mounted in the right side of the trunk behind the trim cover.

The PDC control module activates the ultrasonic sensors mounted in the bumper cover. After activation, the control module monitors the signals coming back through the sensors. Through this signal, the PDC is able to determine the distance to any objects close to the bumpers of the vehicle. As the vehicle comes close to an object, the PDC control module will activate the respective gong (front/rear) at a specific frequency tone.

The PDC control module is linked to the I/K-Bus for the following:

- Vehicle speed
- Transmission range selection
- Diagnosis

Gong/Speaker - The PDC control module activates a gong and a speaker to alert the driver of the detected object. The front mounted gong is the existing check control gong located under the glove box. The rear mounted speaker is located under the right side of the parcel shelf.

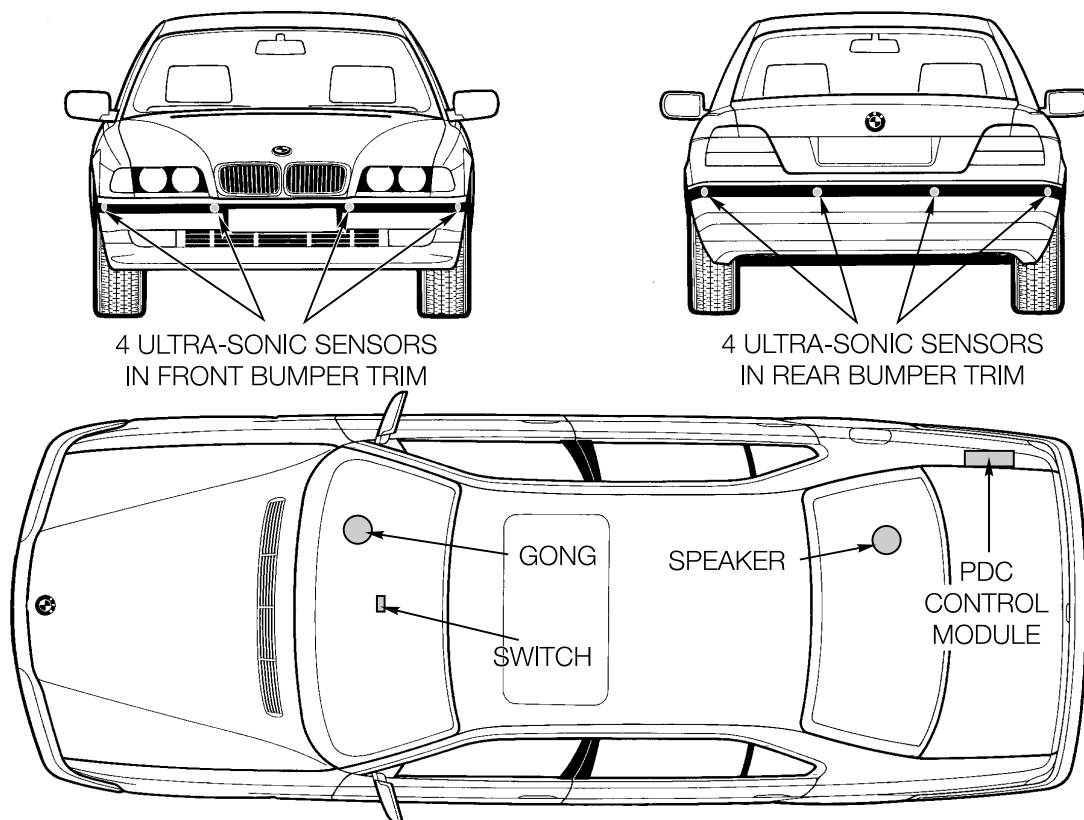



PDC Switch - Mounted in the center console or SZM below the IHKA control panel. The system can be switched "ON"/"OFF" at any time using the switch. The LED in the switch will flash simultaneously with the gong/speaker tones when the system detects an object

Eight Ultra-sonic Sensors - Four sensors each front and rear, mounted in the bumpers. The PDC sensors are small transmitter/receiver modules. They are specifically designed for automotive use. The sensors are limited to the following angles of monitoring:

- 90° on the horizontal plane
- 60° on the vertical plane

The vertical angle is reduced to avoid unintentional signalling on steep grades.

TRANSMITTING MODE

The control module sends a 40 KHz signal to the sensor. The control module activates the sensors in a specific sequence (firing order). The ceramic element in the sensor vibrates and produces an ultra-sonic sound wave that is sent out from the bumper.

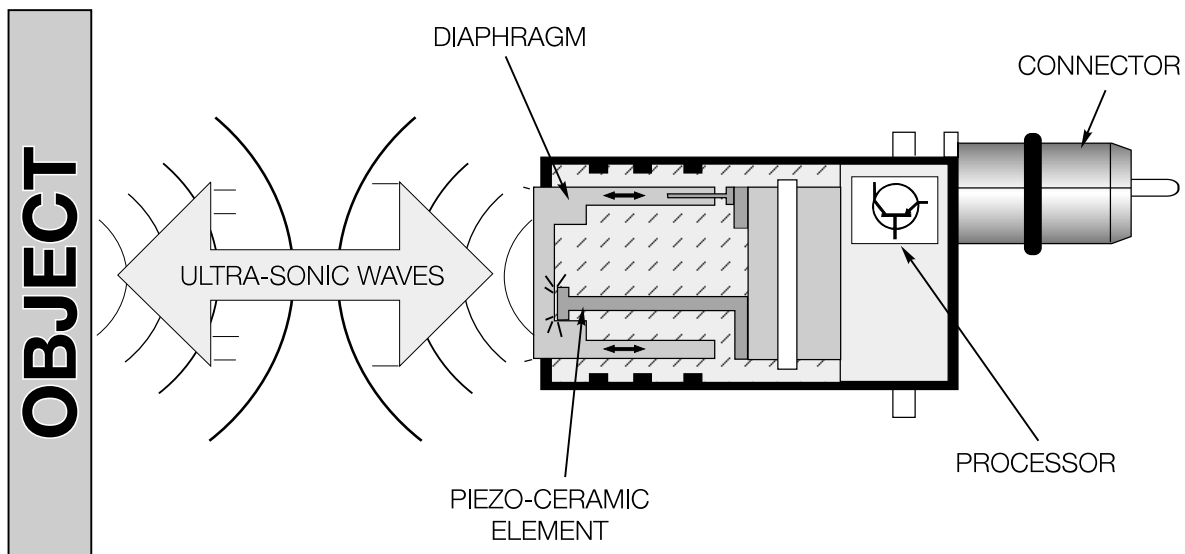

RECEIVING MODE

If the wave contacts an object, the wave is bounced back to the sensor. The returning wave causes the ceramic element to vibrate creating an electrical signal to be fed back to the control module.

The control module determines the distance to the object by the time difference between the sent and received ultra-sonic wave signals. The complete send/receive cycle, for one sensor lasts approximately 30ms (milli-seconds).

SYSTEM OPERATION

When KL15 is switched “ON”, the PDC system is switched “ON”, in the standby mode. The system performs a self-check of the ultrasonic sensors and control electronics.

When the transmission is shifted into reverse, the system is activated and the sensors are activated in the pre-determined order.

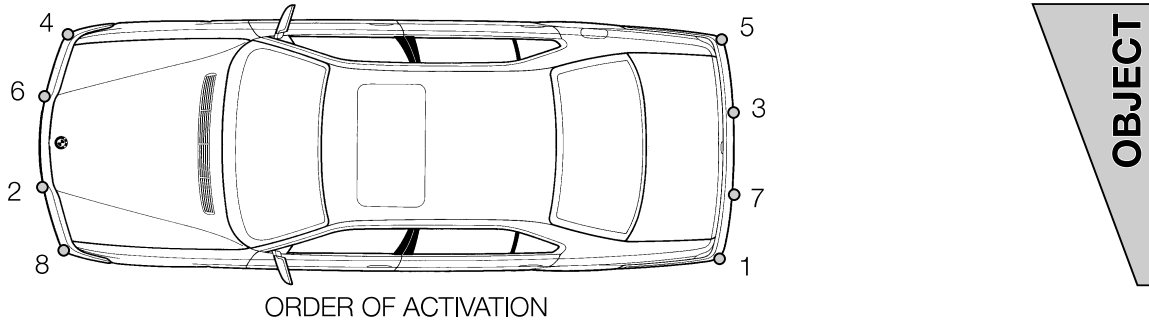

The system stays active up to approximately 20 MPH. Above this, the system reverts to the standby mode.

If an object is detected within the operating range of the sensors, the control module will activate the respective gong/speaker (front/rear). The sensor closest to the object will receive additional activations to determine if the object is getting closer.

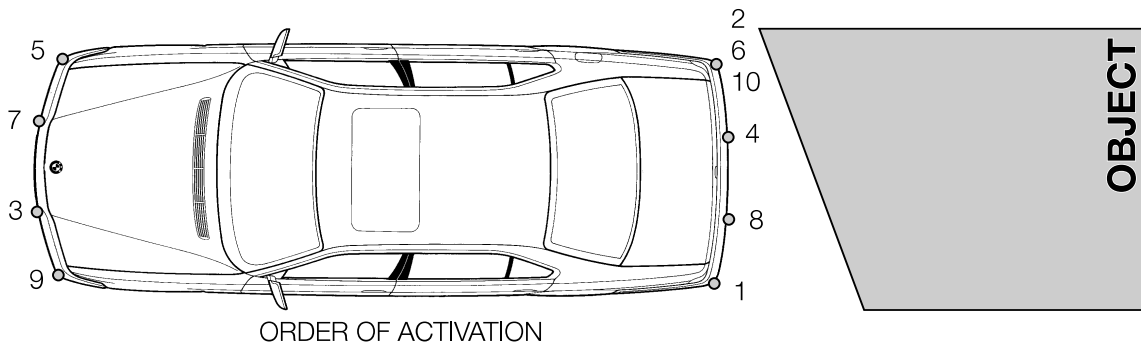

As the distance to the object decreases to approx. 1½ feet, the control module increases the activation frequency of the sensor. The output frequency of the gong will increase linearly up to a distance of approx. ¾ of a foot. At this time the frequency will change to a constant tone.

As the distance to the object increases, the frequency of the sensor and gong activation decreases until the object is out of the monitoring range of the sensor.

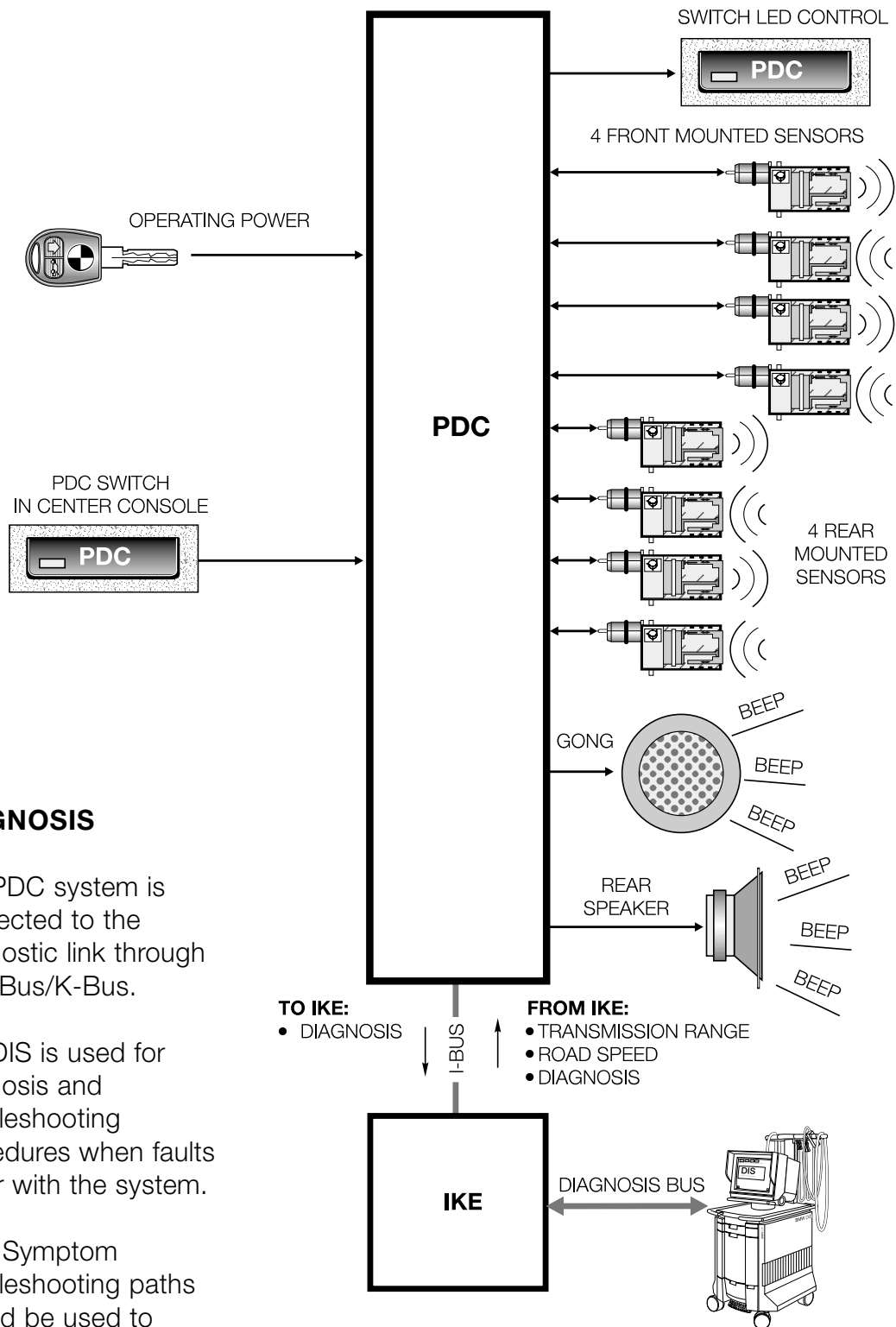

DIAGNOSIS

The PDC system is connected to the diagnostic link through the I-Bus/K-Bus.

The DIS is used for diagnosis and troubleshooting procedures when faults occur with the system.

Fault Symptom troubleshooting paths should be used to troubleshoot failures with the PDC system.

As Introduced

Review Questions

1. Where is mileage and SIA Data stored in an E36 instrument cluster produced after 1997? How is the manipulation dot extinguished? _____

2. Are E36 lights cold monitored by the Check Control system? How is the driver of an E36 warned of a Check Control monitored problem? _____

3. Describe the changes made to the IKE after 9/97. _____

4. Where is mileage and Service Information stored redundantly on a vehicle equipped with an IKE? How is this information exchanged and what could be the cause of the manipulation dot illuminated in the cluster? _____

5. How does the CCM transmit check control data to the IKE? _____

6. Describe the principle differences between the Base cluster and the IKE. When did the CAN bus become an input to the KOMBI? _____

7. Which Base instrument cluster test would be useful in diagnosing a fuel gauge complaint? _____

8. Describe how the IKE controls and monitors external lights. If there was a software failure of the LCM, what lighting functions would still operate in emergency mode? _____

9. Why are Xenon lights only warm monitored? _____

10. What input devices are used by LWR to detect the vehicle load angle? What type of signal is produced? Where are they located? _____

Review Questions, continued

11. What modules produce the display signals for the MID? _____

12. Describe how to enter the Radio Test Function in an E39 vehicle equipped with an MID. _____

13. Describe the changes made to the MFL since its introduction in the E38. _____

14. How does the GR II or the DME receive cruise control inputs from the MFL? _____

15. Where was the GR II main switch moved to after 9/97? _____

16. How can the “NG” radio be distinguished from an earlier radio? _____

17. Which was the first “NG” radio to be used in a production vehicle? _____

18. What is the maximum vehicle speed that PDC can operate at? _____

19. What diagnosis is available to address a PDC complaint? _____
